

ADVANCED ENDOSCOPY DEVICES

Surgical Instruments

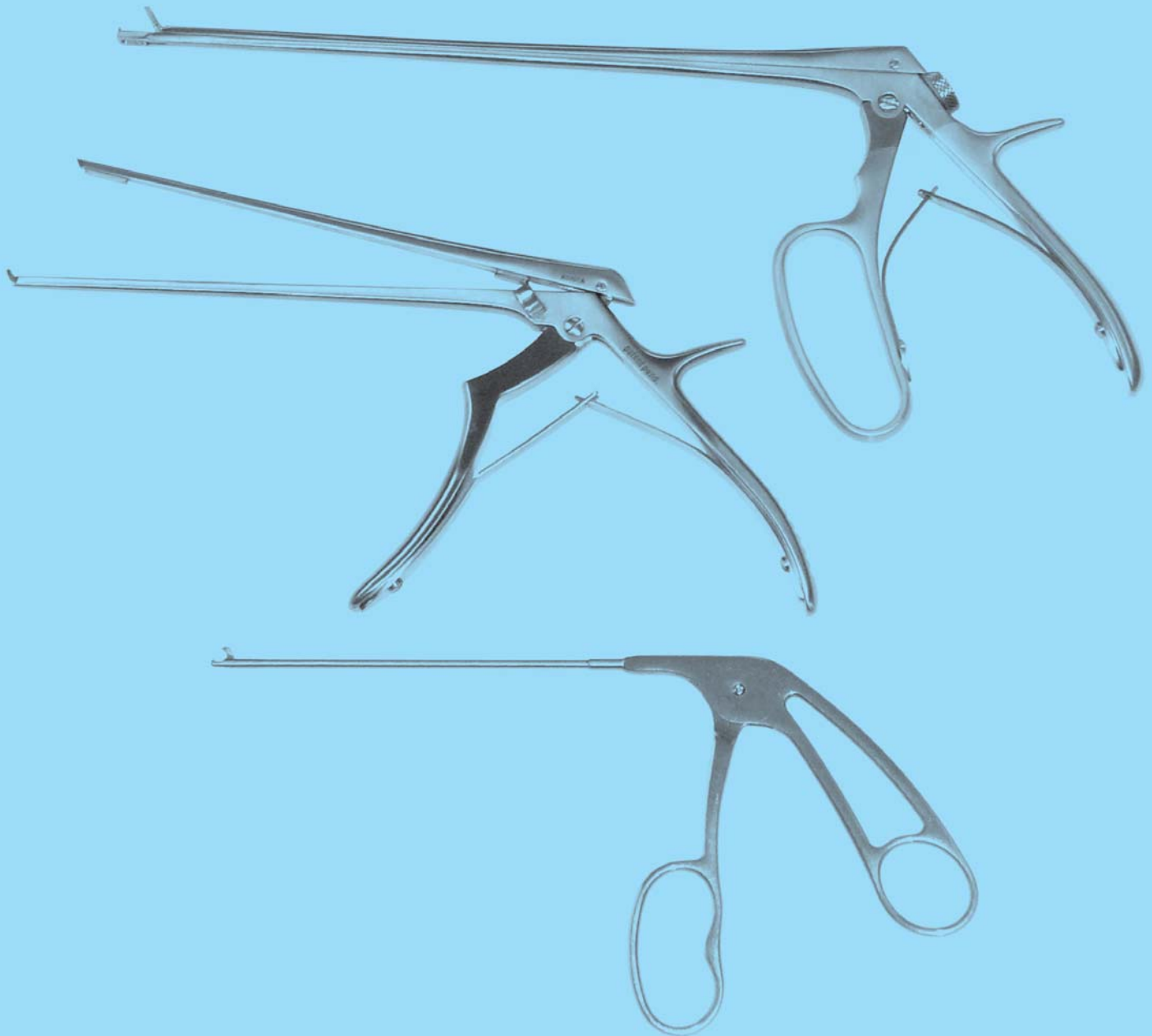

TERMS AND CONDITIONS

GUARANTEE

All instruments presented in the catalog are crafted from the finest German stainless steel.

These products are guaranteed to be free from defects in workmanship and materials.

Any original product, which proves defective in workmanship or materials, will be repaired or replaced at our discretion, free of charge.

RETURNS

No returns will be accepted without proper authorization. To speed authorization, please provide us with the invoice and order date when you call and ask for a Return Authorization Number.

Merchandise must be unused and in original packaging. Returns are subject to a 10% restocking fee.

CLAIMS

All claims must be made within seven days after receipt of the merchandise.

Use medical instruments only for original purposes intended for.

Custom or modified instruments cannot be returnable for credit.

INSTRUMENT CARE AND MAINTENANCE

Before each use clean, sterilize and inspect instrument. For all end users the Manufacturer recommends following steps:

CLEANING

Water and stainless steel

Ordinary tap water contains minerals, which may cause discoloring and corrosion. We recommend the use of **distilled water** for cleaning, disinfecting, sterilizing and rinsing instruments. In order to avoid corrosion use a cleaning solution with a near-neutral pH (7).

Ultrasound Cleaning

The ultrasound method is the most effective and efficient method for cleaning surgical instruments. In order to raise the effectiveness first clean the instruments of any visible residue before placing them in ultrasonic cleaner. We recommend following the rules specified below:

- Do not mix in same cycle instruments made of stainless steel and instruments made of carbon steel covered with a galvanizing layer
- Open all the instruments so that locks and latches are accessible
- Avoid stacking instruments one over the other during loading
- Remove and rinse the instruments immediately after cycle end

- Dry the instruments immediately after rinsing and leave them in open air to dry completely
- Lubricate all movable parts

Attention: after ultrasound cleaning perform a careful inspection of the instruments in terms of potential loosening of particular parts, e.g. loose screws

Manual cleaning and soaking

If ultrasound-cleaning equipment is not available the instruments should be cleaned very carefully. Special attention should be paid to cleaning locks, teeth, hinges and other difficult to access areas. For cleaning use nylon (not steel) brushes and warm (not hot) cleaning solutions. Follow the manufacturer's instructions while preparing solutions. Change the solution in accordance with the manufacturer's recommendations.

Instruments should be treated with utmost care in order not to damage their delicate tips and mechanisms. If the instruments came into contact with blood, tissue, physiological saline or other foreign substances, they should be rinsed with warm (not hot) water before the substance dries up on the instruments. After rinsing, dip the instrument in a cleaning and disinfecting solution. Do not exceed the maximum treatment time and temperature.

Clean and rinse the instruments immediately after each application to achieve the best results. Delayed cleaning may result in particles sticking to the instruments or secretions drying up making them resistant to cleaning, and in the future difficult or even impossible to sterilize.

Since many chemical compounds and substances have a strong corrosive effect on stainless steel, instruments should be immediately rinsed and dried if they were exposed to any potentially hazardous substances.

INSPECTION

Before each use check and test the instruments. Visible defects, cracks, deformed elements or blunt blades indicate that the instruments require repair and must not be used.

Inspection of instruments

The best time to check the condition of the instruments is after cleaning and lubrication, after they have cooled down. The application of defective instruments is strictly forbidden. Never attempt to repair the instruments on your own. Exclusively trained and qualified technicians should carry out servicing and repair work. Questions concerning repair should be reported to the manufacturer.

Upon inspection pay attention to:

Performance – pliers, forceps and scissors must cut smoothly and close properly. Needle handles and clips must close properly and their tips must meet.

Surface – inspect the surface carefully in search for traces of discoloring, cracks or other irregularities. The most common reasons for discoloring and corrosion are:

- *Improper cleaning*
- *Simultaneous sterilization of instruments made of stainless steel and carbon steel covered with a chrome layer*
- *Water contamination*
- *Inadequate or improper preparation and use of improper cleaning, disinfection or maintenance agents*
- *Failure to observe operating procedures for cleaning and sterilization*

LUBRICATION

After cleaning the instruments and prior to sterilization in an autoclave lubricate all movable parts. If the instruments are to be sterilized in vapor, the use of an authorized water-soluble lubricant is recommended (in accordance with the instructions attached to the instrument).

STERILIZATION

Sterilization guidelines compliant with the relevant national regulations should be adhered to. Proper parameters regarding the sterilization time, temperature and pressure should be taken from the instruction provided by the sterilization equipment manufacturer.

Lubrication and autoclave sterilization

All instruments must be properly cleaned before being placed in the autoclave. Next, their movable parts such as locks or hinges should be lubricated thoroughly. Use lubricants recommended in the user's manual enclosed with each AED instrument. Do not use industrial oils. Always sterilize equipment in their open position. It is recommended to wrap instruments in a cloth and then place them in the container or to spread the cloth on the bottom of the container so that it absorbs humidity. The cloth should be of neutral pH (7) and free of any detergent residue. Before application leave the instrument to cool down freely to room temperature. Follow the manufacturer's instructions on vapor autoclave operation and loading.

IMPORTANT NOTICE

The drawings in the catalog are made to a 1:1 scale and pictures to 1:2 scale, in other cases it will be specified next to the presented instrument. AED reserve the right to modify or change specification at its own discretion.

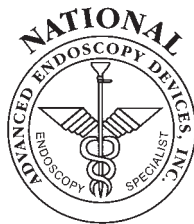

Advanced Endoscopy Devices

22134 Sherman Way
Canoga Park, CA 91303 • USA
Phone: (818) 227-2720
Fax: (818) 227-2724
www.aed.md

CONTENTS

GENERAL SURGERY INSTRUMENTS.....	7-26
Scissors	7 - 8
Needle Holders	9- 10
Micro Needle Holders and Micro Scissors	11-13
Hemostatic Forceps	14-17
Atraumatic Forcep	18,19
Dressing and Tissue Forceps	20-22
Tubing Occluding Forceps	23
Retractors and Towel Clamps	24
Scalpel Handles and Scalpel Blade Removers	25
Suture Instruments and Scissors	26
BONE SURGERY INSTRUMENTS	27-41
Bone Cutting and Holding Forceps.....	27, 28
Ronguers	29-32
Bone Holding Forceps	32, 33
Bone Elevators	33, 34
Gouges, Mallets	34, 35
Bone Rasps	35, 36
Retractors	36
Curettes	37
Wire and Pin Cutters with T.C. Inserts	38, 39
Wire Pliers	40
Wire Pullers	40
Wire and Plate Scissors	40
Wire Twisters	40
General Utility Pliers	41
NAIL INSTRUMENTS	42-45
Nail Nippers	42-44
Tissue and Cuticle Nippers	44-45
Nail Scissors	45
MISCELLANEOUS	46-52
Nasal Speculums	46
Tenaculum Forceps	46
Tongue Seizing Forceps	46
Cast Instruments	47
Bandage Scissors	47
Left Handed Scissors	47
Universal Laboratory S.S Forceps	48
Kwik Kleen Kerrison	49
Champion Kerrison	50
Ronguer –Punch’s	51
Arthroscopy Forcep	52

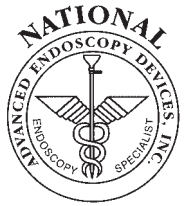

SCISSORS

MAYO Operating Scissors

Straight

Curved

Code no		Size		Code no
8-007-302	standard	5 1/2"-14,5 cm	standard	8-008-312
8-007-302 S	Sup.-Cut		Sup.-Cut	8-008-312 S
8-007-302 H	T.C.		T.C.	8-008-312 H
8-007-305	standard	6 3/4"-17 cm	standard	8-008-315
8-007-305 S	Sup.-Cut		Sup.-Cut	8-008-315 S
8-007-305 H	T.C.		T.C.	8-008-315 H

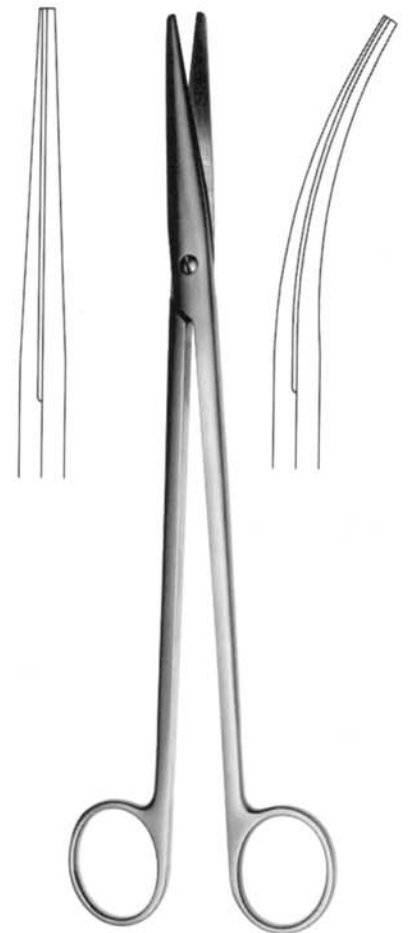
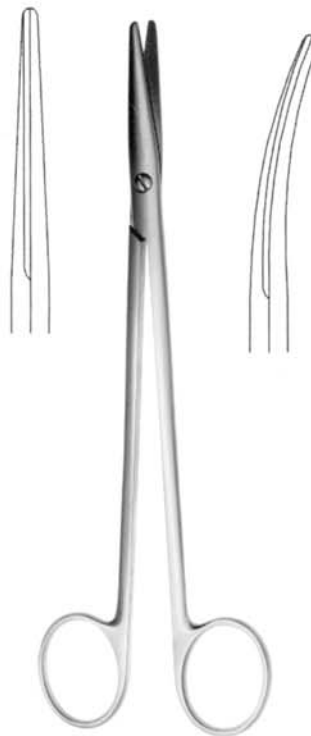
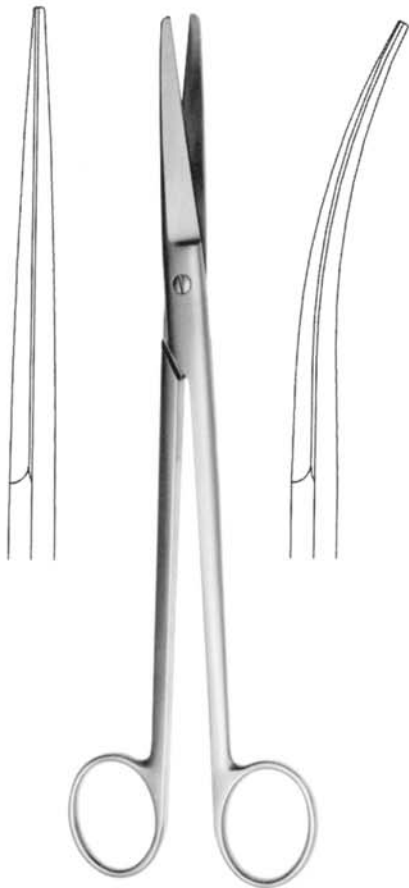
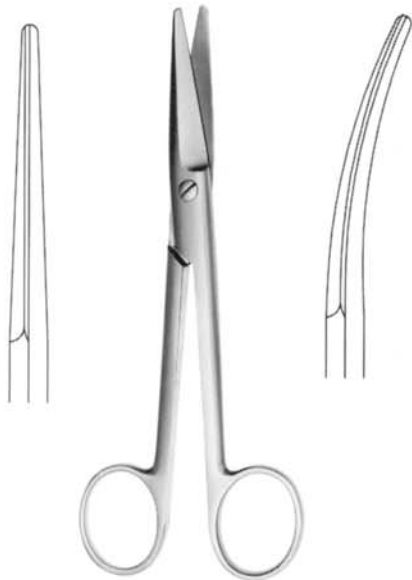

METZENBAUM Tonsil Scissors

Straight and slightly curved

Size		Code no
7 1/4"-18,5 cm	straight	8-226-585
	str., Sup.-Cut	8-226-585 S
	curved	8-226-588
	cvd., Sup.-Cut	8-226-588 S

NELSON Dissecting Scissors

Curved, Blunt-Blunt

Size		Code no
9 1/2"-24cm	straight	8-013-611
	curved	8-014-612

MAYO -HARRINGTON Scissors

Size		Code no
9"-23 cm	straight	8-011-502
	curved	8-012-512

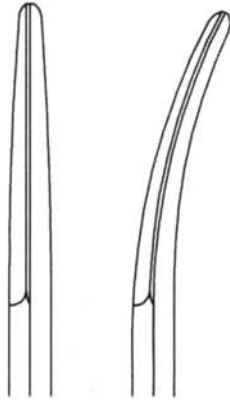

Standard Operating Scissors

Size			Code no
5 1/8"-13 cm	straight	Sharp-Blunt	8-004-052
	curved		8-004-053
	straight	Blunt-Blunt	8-004-054
	curved		8-004-055
	straight	Sharp-Sharp	8-004-056
	curved		8-004-057

Note: Other sizes 5 3/4", 6 1/2", 7 1/4" also available

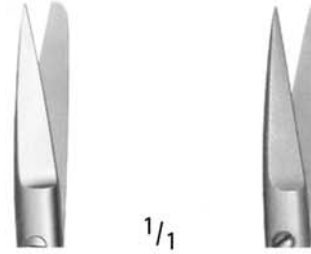

1/1

Straight Operating Scissors

Size			Code no
5 3/4"-14,5 cm	Sup. Cut	Sharp-Blunt	8-002-112 S
	standard	Sharp-Sharp	8-003-122

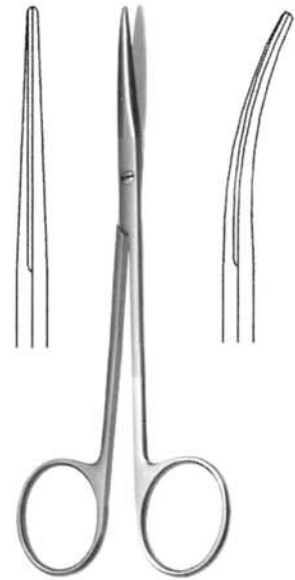
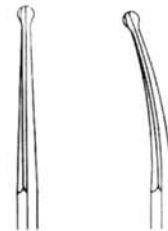
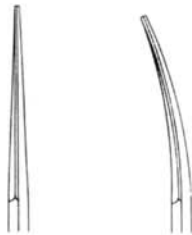

IRIS

Size		Code no
4 1/4"-11 cm	straight	8-203-287
	curved	8-204-288
	cvd., one blade serrated, T.C.	8-204-388 H

Eye Scissors with Probe Points

Size		Code no
4 1/4"-11 cm	straight	8-202-270
	curved	8-202-271

METZENBAUM

Size		Code no
5 3/4"-14,5cm	straight	8-009-402
	curved	8-010-412

METZENBAUM, Delicate

Size		Code no
5 3/4"-14,5cm	straight	8-009-400
	curved	8-010-410

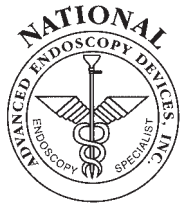

MATHIEU Needle Holders

	Size		Code no
A	6 3/4"-17 cm		8-028-917
		T.C.	8-028-917 H
B	8"-20 cm		8-028-920
C	9 1/2"-24 cm		8-028-924
D	5 1/2"-14 cm		8-605-014
E	4 7/8"-12,5 cm	MINI	8-605-125
	5 1/2"-14 cm		8-605-015
F	5 1/2"-14 cm		8-605-914
		T.C.	8-605-914 H
		2-SP	8-605-9140
		2-SP, T.C.	8-605-904 H
G	5 1/2"-14 cm		8-605-915
			8-605-915 E <small>(smooth handles)</small>
		T.C.	8-605-915 H
		2-SP	8-605-9150

NEEDLE HOLDERS

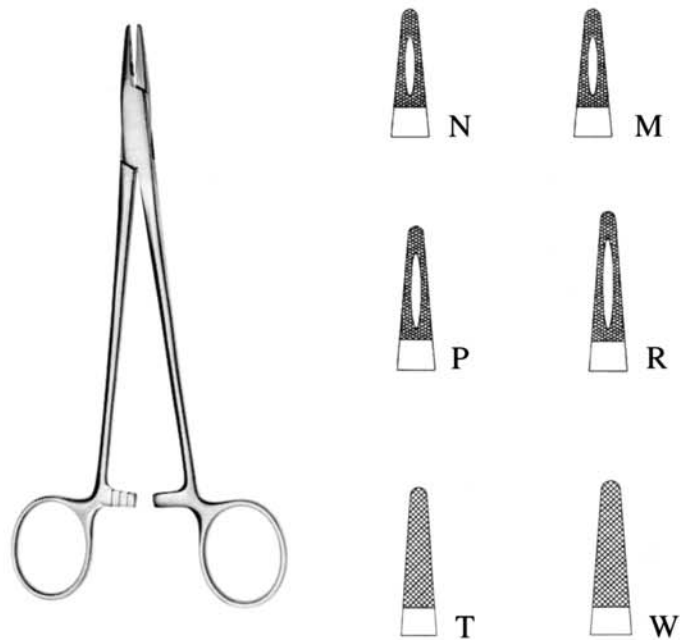
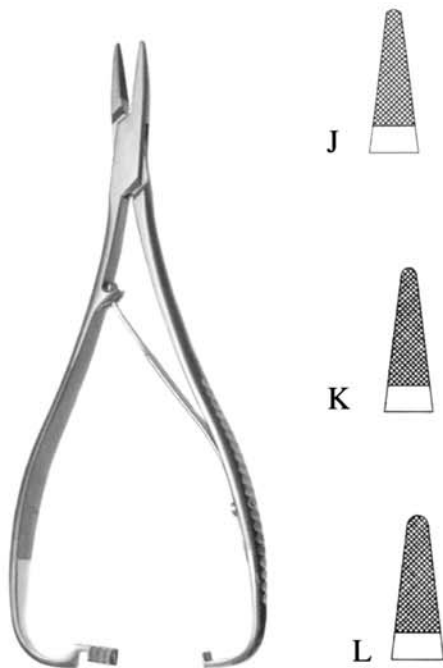
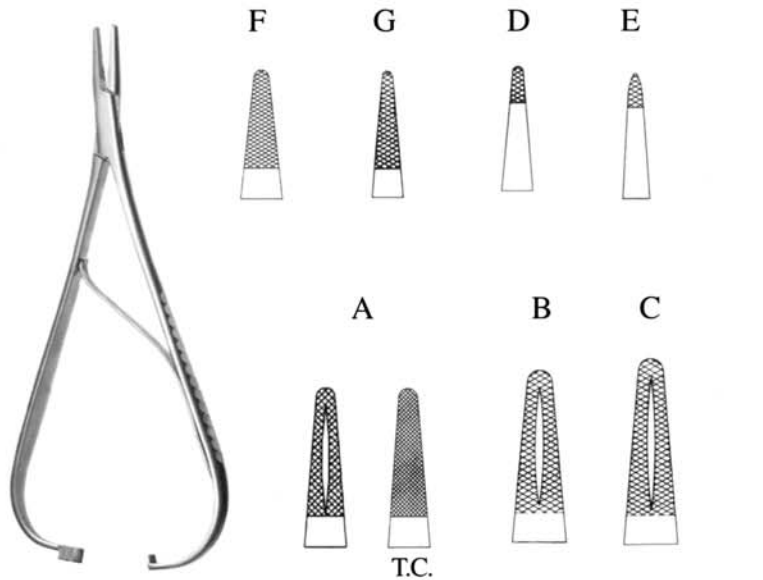

MATHIEU Needle Holders

	Size		Code no
J	6 1/4"-16 cm	T.C.	8-605-160 H
K	7 1/2"-19 cm	T.C.	8-605-190 H
L	8 1/4"-21 cm	T.C.	8-605-210 H

MAYO-HEGAR Needle Holders

	Size		Code no
M	6"-15 cm		8-027-750
		T.C.	8-027-750 H
N	6 1/4"-16 cm		8-027-755
P	7"-18 cm		8-027-760
		T.C.	8-027-760 H
R	8"-20 cm		8-027-765



HEGAR, Delicate

Size		Code no
6" - 15cm	T.C.	8-028-815 H



HALSEY

Size		Code no
5 1/8" - 13 cm	T.C.	8-028-816 H

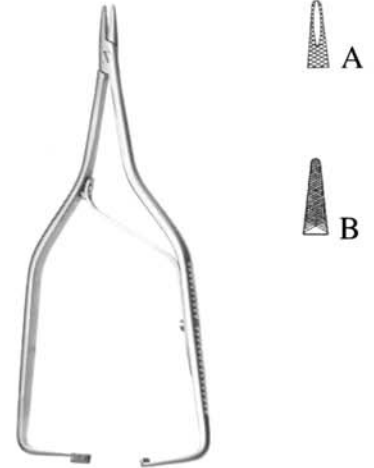

BOYNTON, Delicate

	Size	Code no
A	4 7/8" - 12,5 cm	8-028-125
B		8-028-127

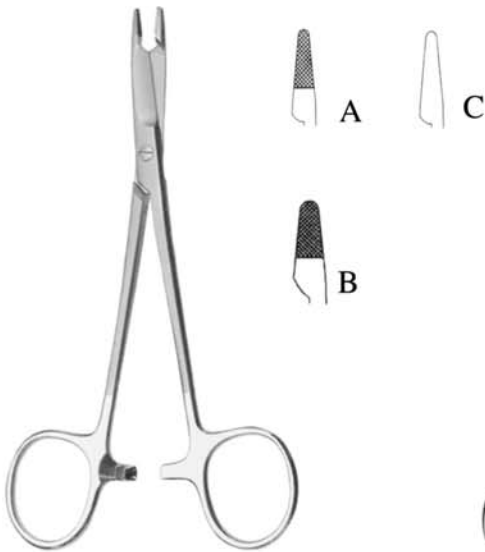

OLSEN-HEGAR with Suture Scissors

	Size		Code no
A	5 3/4" - 14,5 cm	T.C.	8-028-950 H
B	6 3/4" - 17 cm	T.C.	8-028-970 H
C	5 3/4" - 14,5 cm	T.C. smooth inserts	8-028-950 S

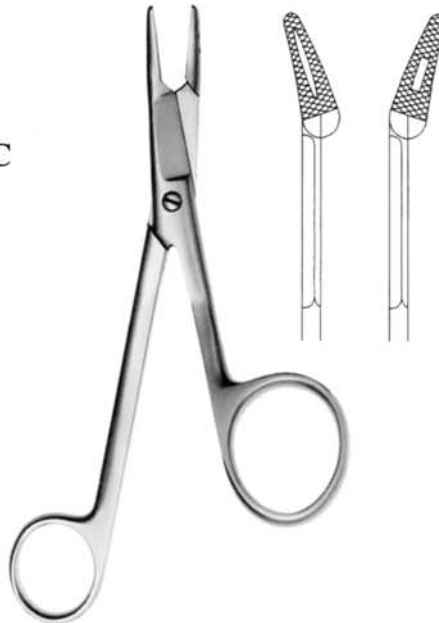

Needle Holder with Suture Scissors, one fenestrated jaw and one angled finger ring

Size	Code no
6 1/4" - 16 cm	8-036-399

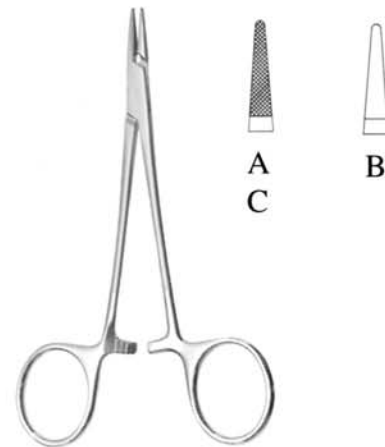

WEBSTER

	Size		Code no
A	4 3/4" - 12 cm	T.C.	8-028-700 H
B		T.C. smooth inserts	8-028-700 S
C		T.C.-7*)	8-028-707 H

*) Note

T.C. : 4.000 teeth p.sq. inch

T.C.-7 : 7.000 teeth p.sq. inch

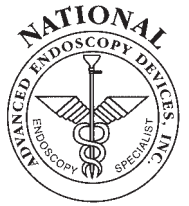

MICRO NEEDLE HOLDERS AND MICRO SCISSORS



CASTROVIEJO, flat handle, with lock

	Size	Code no
A	5"-12,5 cm	8-028-1021
	5 5/16"-13,5 cm	8-028-1023
B	6 1/4"-16 cm	8-028-1025
C	5"-12,5 cm	8-028-1022
	5 5/16"-13,5 cm	8-028-1024
D	6 1/4"-16 cm	8-028-1026



CASTROVIEJO, flat handle

	Size	Code no
A	4 3/8"-11 cm	8-028-0021
B	4 3/8"-11 cm	8-028-0022
A	5"-12,5 cm	8-028-0023
B		8-028-0024
A	5 5/16"-13,5 cm	8-028-0025
B		8-028-0026



CASTROVIEJO, flat handle, with lock, serrated jaws

Size	Code no
5 5/16"-13,5 cm	8-028-1033

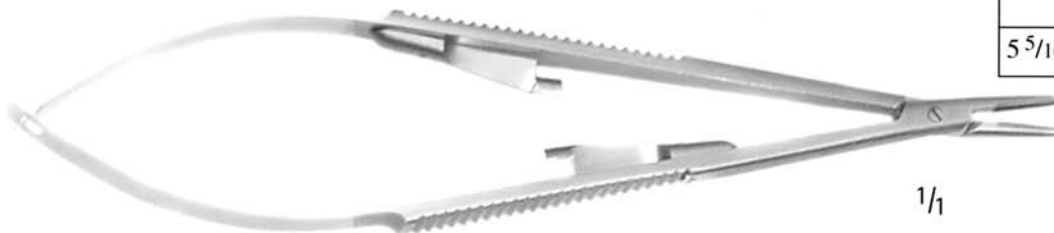

Micro Needle Holders, with lock, flat handle, with T.C. inserts

Size	Code no
5 5/16"-13,5 cm	8-028-003H



**Micro Needle Holders,
with round handle**

Size	Code no
4 3/8"-11 cm	8-028-0131



**Micro Scissors, flat
handle, angled blades,
blunt points**

Size	Code no
4 3/8"-11 cm	8-025-0012



Micro Scissors, flat handle

	Size		Code no
A	4 3/8"-11 cm	sharp points	8-025-0041
B			8-025-0042
A	4 3/8"-11 cm	blunt points	8-025-0051
B			8-025-0052



**Micro Scissors, flat handle, inner
blade 0,5 mm longer, blunt tips**

Size		Code no
4 3/8"-11 cm	left	8-025-0211
	right	8-025-0213



**Micro Scissors, flat handle
blunt tips**

Size	Code no
4 3/8"-11 cm	8-028-0233

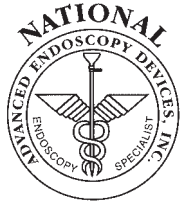

**Micro Scissors,
Flat Handle 4 3/4" - 12 cm**

		Code no
sharp	straight	8-025-0131
	curved	8-025-0132
blunt	straight	8-025-0141
	curved	8-025-0142



**Micro Tissue Holding
Scissors**

Size	Code no
4 3/8"-11 cm	8-025-0071

Micro Scissors, Delicate

	Size	Code no
A	3 3/8"-8,5 cm	8-025-0101
B		8-025-0102
C		8-025-0109

Micro Scissors, Very Delicate

	Size	Code no
E	3 3/8"-8,5 cm	8-025-1101
F		8-025-1102
G		8-025-1109

HEMOSTATIC FORCEPS

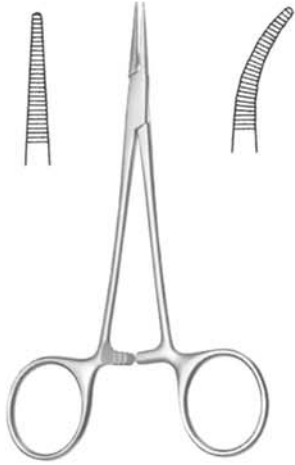

HALSTED Hemostatic Forceps

Size		Code no
5" - 12,5 cm	straight	8-119-921
	curved	8-120-926

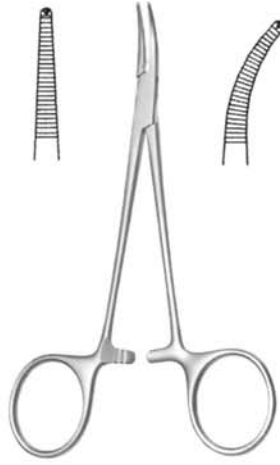

HALSTED Hemostatic Forceps, 1x2 teeth

Size		Code no
5" - 12,5 cm	straight	8-122-933
	curved	8-122-936

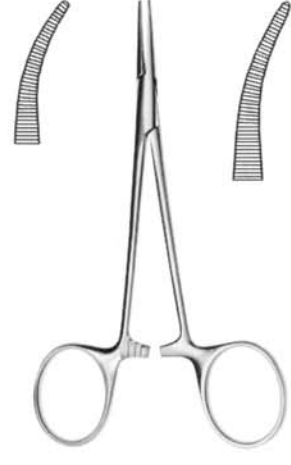

Micro HALSTED-MOSQUITO Hemostatic Forceps, curved

Size		Code no
4 3/4" - 12 cm	micro	8-120-900
6 1/4" - 16 cm	delicate	8-120-930

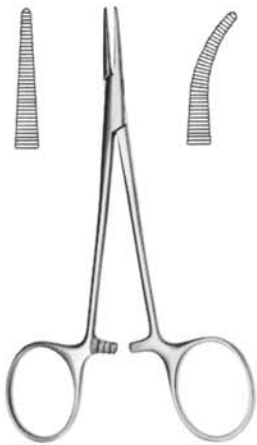

HALSTED-MOSQUITO Hemostatic Forceps

Size		Code no
4 3/4" - 12 cm	straight	8-123-171
	curved	8-125-176

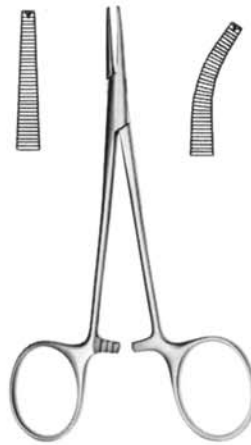

HALSTED-MOSQUITO Hemostatic Forceps, 1x2 teeth

Size		Code no
4 3/4" - 12 cm	straight	8-124-172
	curved	8-124-175

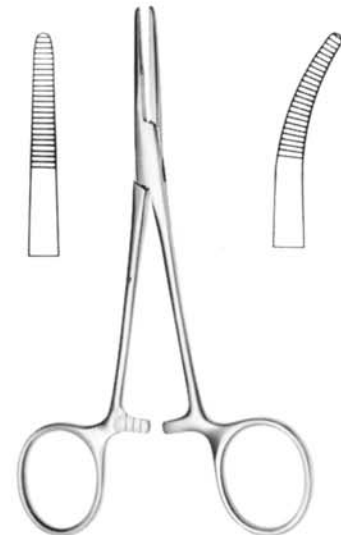

KELLY Hemostatic Forceps

Size		Code no
5 1/2" - 14 cm	straight	8-127-281
	curved	8-128-286

PEAN Hemostatic Forceps

Straight

Size	Code no
5 1/2" - 14 cm	8-110-714
6 1/4" - 16 cm	8-110-716
7" - 18 cm	8-110-718
8" - 20 cm	8-110-720
9 1/2" - 24 cm	8-110-724

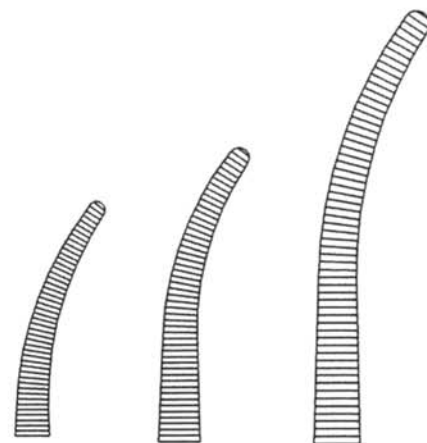
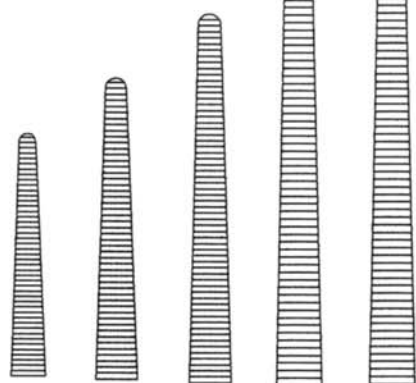

PEAN Hemostatic Forceps

Curved

Size	Code no
5 1/2" - 14 cm	8-111-814
6 1/4" - 16 cm	8-111-816
8" - 20 cm	8-111-820



KOCHER Hemostatic Forceps

1x2 teeth, Straight

Size	Code no
6 1/4" - 16 cm	8-108-716
7" - 18 cm	8-108-718

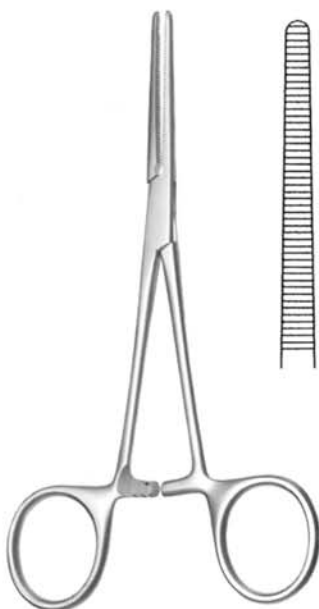

ROCHESTER-PEAN Hemostatic Forceps

Straight

Size	Code no
6 1/4" - 16 cm	8-114-365

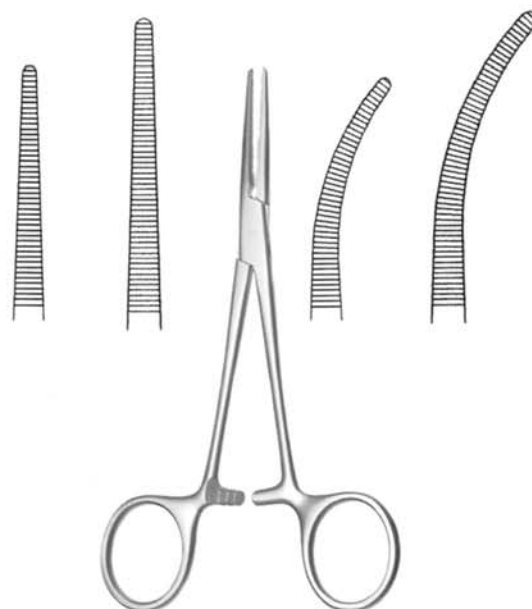

CRILE Hemostatic Forceps

Size		Code no
5 1/2" - 14 cm	straight	8-117-514
6 1/4" - 16 cm		8-117-516
5 1/2" - 14 cm	curved	8-118-524
6 1/4" - 16 cm		8-118-526

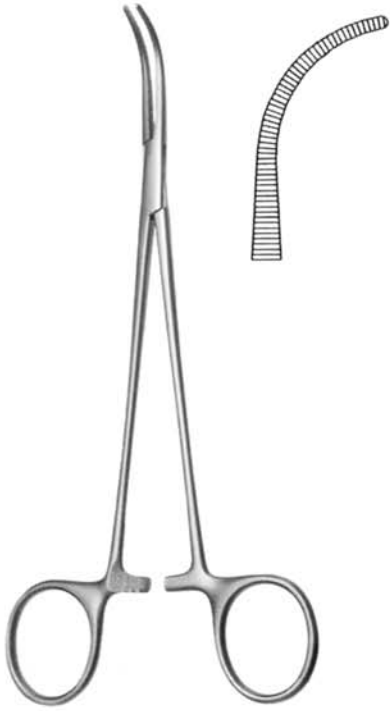

**HOEPFNER
Hemostatic Forceps**

Size	Code no
6 1/2" - 16,5 cm	8-129-316

**HEISS
Hemostatic Forceps**

Size	Code no
8" - 20 cm	8-130-384

Size	Code no
7" - 18 cm	8-109-181



**Micro HALSTED
Hemostatic Forceps**

	Size	Code no
A	5" - 12,5 cm	8-119-924
B		8-120-927

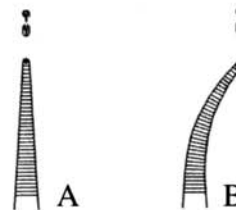
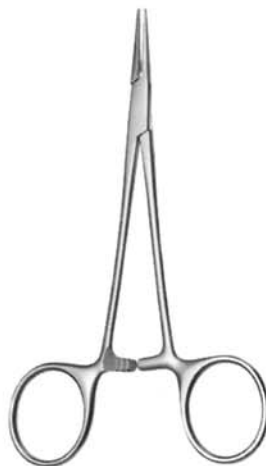

**Micro HALSTED
Hemostatic Forceps, 1x2 teeth**

	Size	Code no
A	5" - 12,5 cm	8-119-925
B		8-120-928

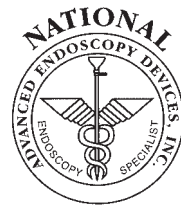

1/1

Bulldog Clamps

	Size	Code no
A	2 3/8" - 6 cm	8-131-203
B		8-131-204

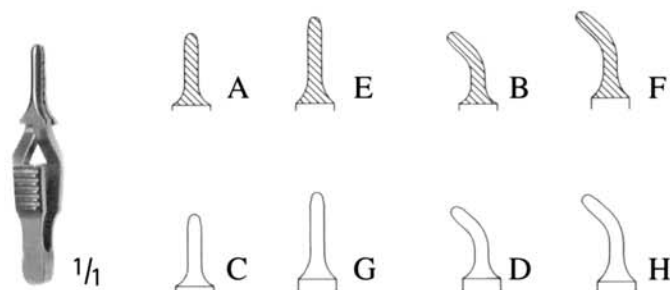

Bulldog Clamps

			Size	Code no
A	straight	serrated	1 3/16" - 3 cm	8-131-101
B	curved			8-131-102
C	straight	smooth		8-131-103
D	curved			8-131-104
E	straight	serrated	1 3/8" - 3,5 cm	8-131-105
F	curved			8-131-106
G	straight	smooth		8-131-107
H	curved			8-131-108

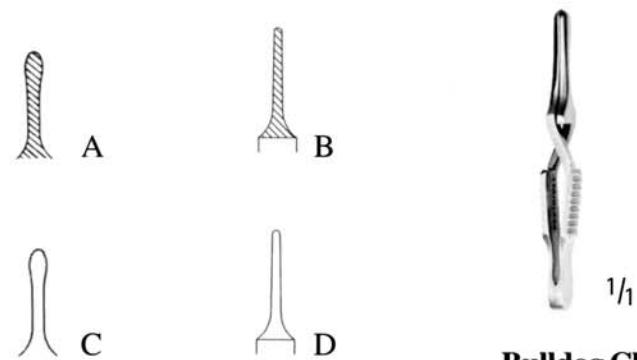

1/1

Bulldog Clamps

	Size	Code no			Size	Code no
A	1 9/16" - 4 cm	8-131-321	straight	serrated	1 3/4" - 4,5 cm	8-131-451
B		8-131-322				8-131-452
C		8-131-323		smooth		8-131-453
D		8-131-324				8-131-454
E		8-131-325	curved	serrated		8-131-455
F		8-131-326				8-131-456
G		8-131-327		smooth		8-131-457
H		8-131-328				8-131-458

ATRAUMATIC FORCEPS

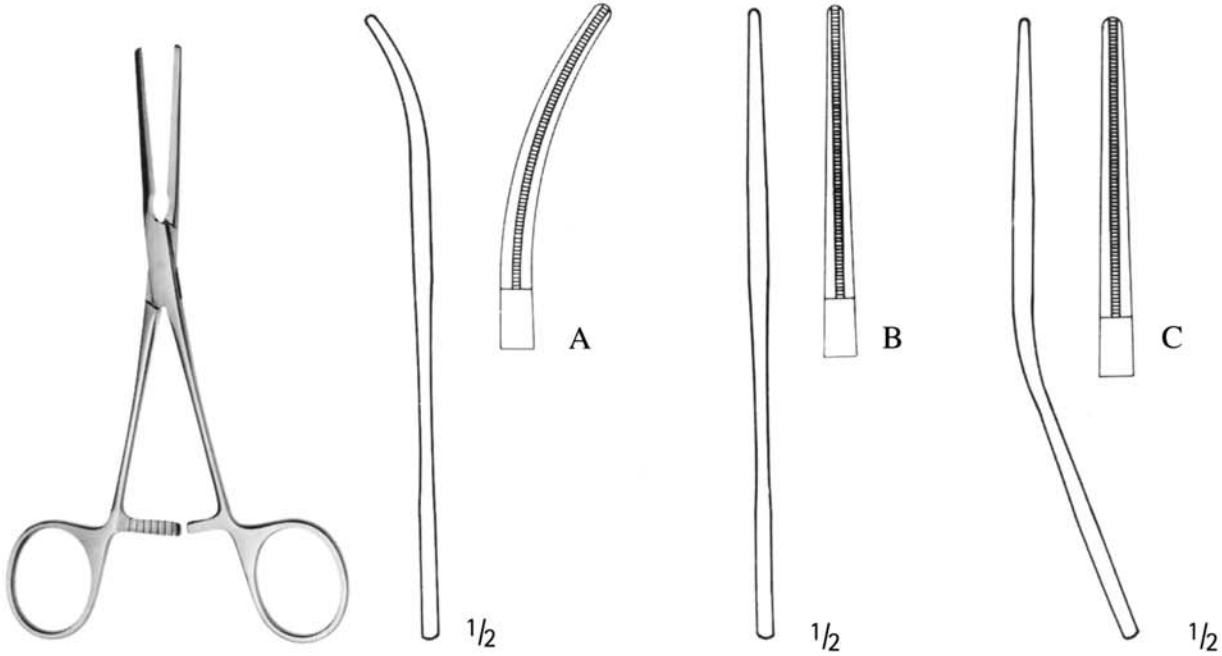

DE BAKEY

	Size		Code no
A	6 1/4"-16,5 cm	curved	8-107-145
B		straight	8-107-146
C		angled	8-107-149

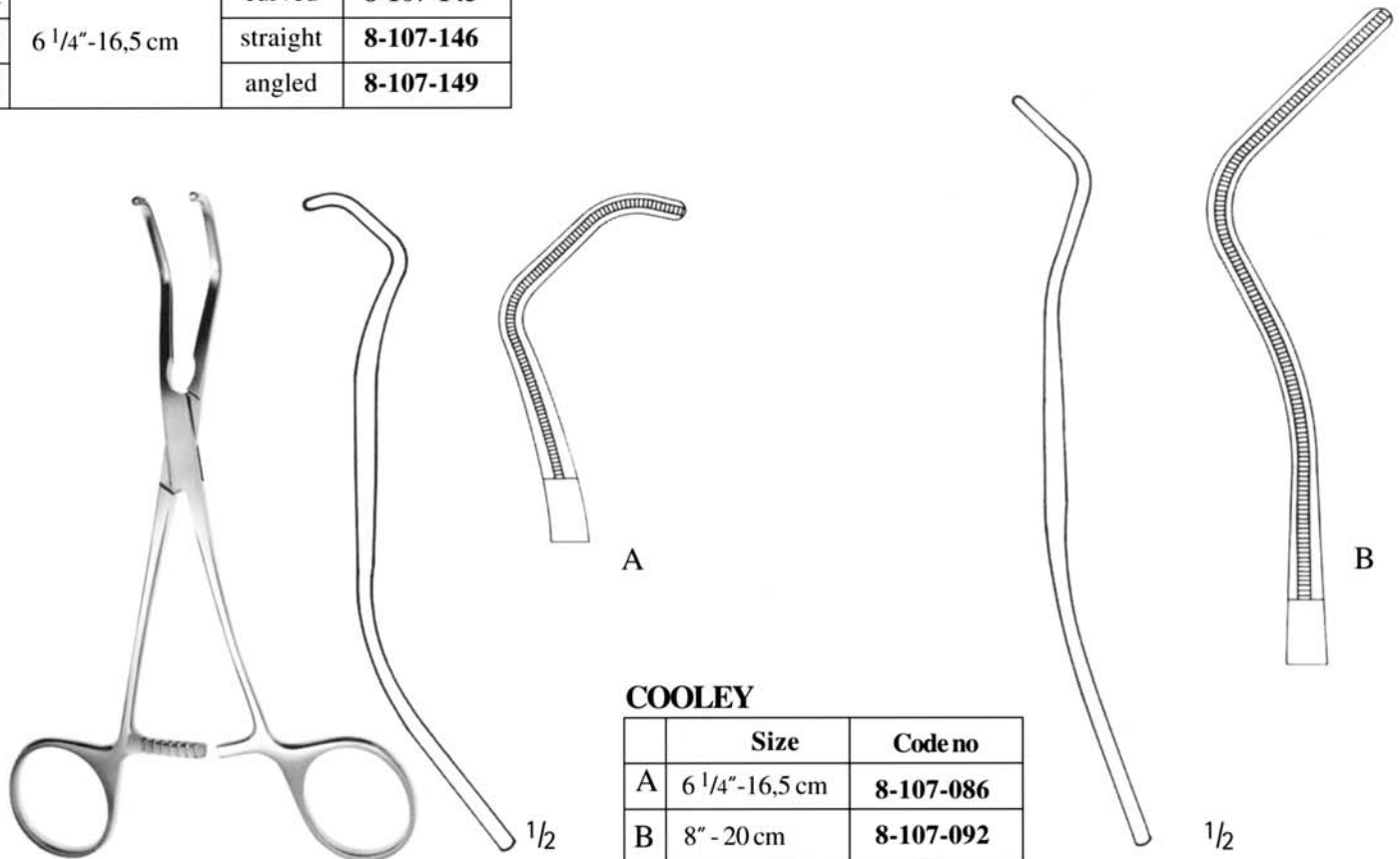

COOLEY

	Size	Code no
A	6 1/4"-16,5 cm	8-107-086
B	8"-20 cm	8-107-092

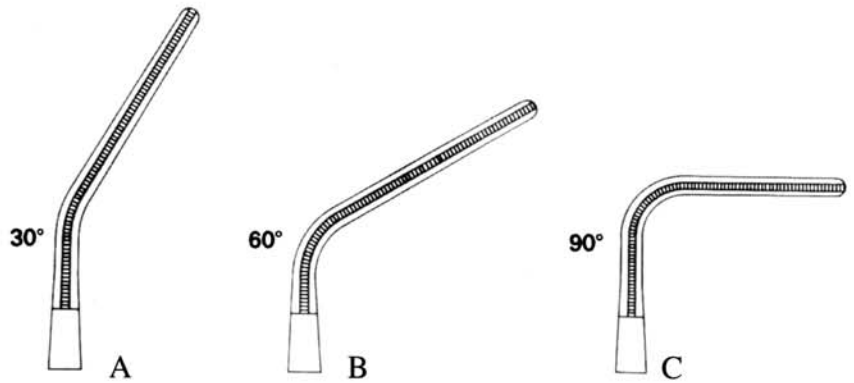
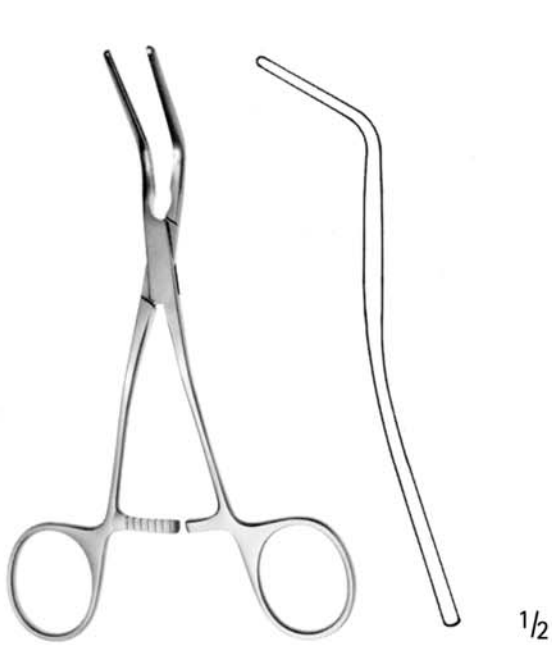
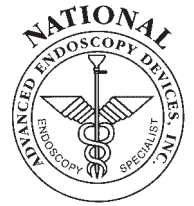

COOLEY

	Size	Code no
A	6 1/4" - 16,5 cm	8-107-230
B	6" - 15 cm	8-107-260
C	5 1/2" - 14 cm	8-107-290

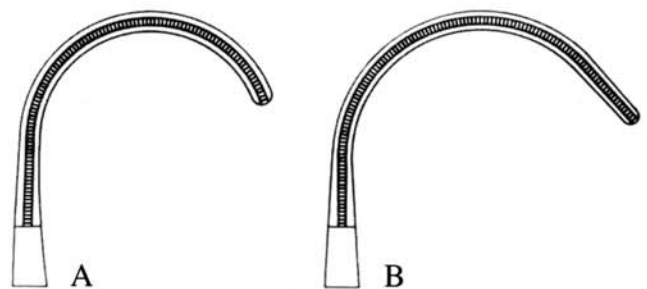
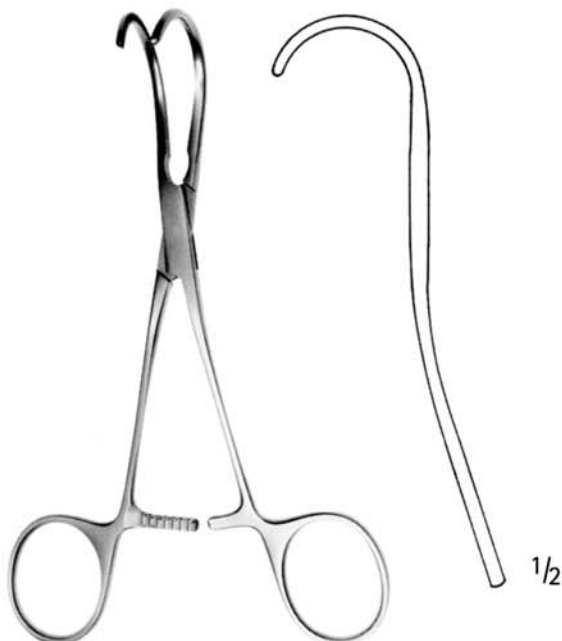

DE BAKEY

	Size	Code no
A	6" - 15 cm	8-107-137
B	6" - 15 cm	8-107-139

DRESSING AND TISSUE FORCEPS

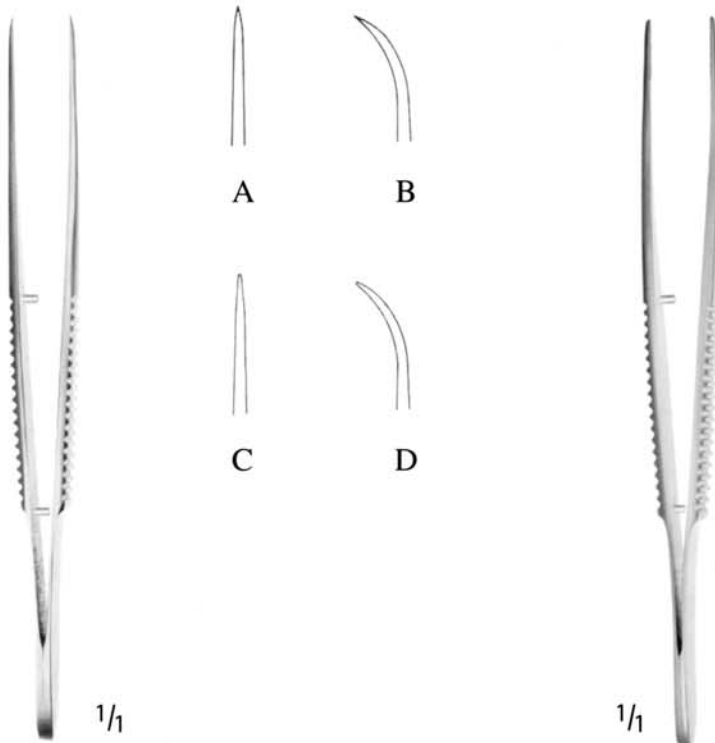

Dressing Forceps, Serrated Tips

Straight	Size	a x b	Curved
8-018-0150	3 3/4" - 9,5 cm	0,5 x 0,4 mm	8-018-0152
8-018-0154		0,6 x 0,5 mm	8-018-0156
8-018-0158		0,9 x 0,7 mm	8-018-0160
8-018-0162		1,3 x 1,0 mm	8-018-0164
8-018-0166		1,6 x 1,2 mm	8-018-0168
8-018-0170		1,8 x 1,4 mm	8-018-0172
8-018-0102	5" - 12,5 cm	0,5 x 0,4 mm	8-018-0104
8-018-0106		0,6 x 0,5 mm	8-018-0108
8-018-0110		0,9 x 0,7 mm	8-018-0112
8-018-0114		1,3 x 1,0 mm	8-018-0116
8-018-0118		1,6 x 1,2 mm	8-018-0120
8-018-0122		1,8 x 1,4 mm	8-018-0124

Delicate Forceps

	Size			Code no
A	3 3/4" - 9,5 cm	sharp points	straight	8-018-0211
B			curved	8-018-0212
C		blunt points	straight	8-018-0215
D			curved	8-018-0216

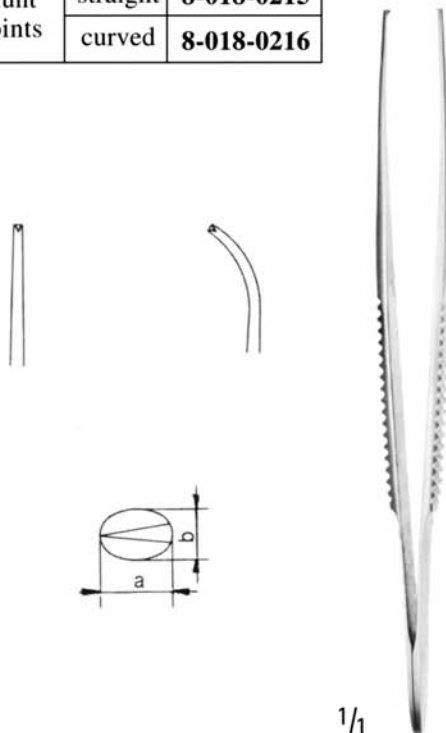

Tissue Forceps, Delicate Pattern 1x2 Teeth

Straight	Size	a x b	Curved
8-018-0000	3 3/4" - 9,5 cm	0,4 x 0,25 mm	8-018-0002
8-018-0004		0,5 x 0,35 mm	8-018-0006
8-018-0008		0,7 x 0,55 mm	8-018-0010
8-018-0012		1,0 x 0,8 mm	8-018-0014
8-018-0016		1,2 x 0,9 mm	8-018-0018
8-018-0020		1,4 x 1,1 mm	8-018-0022
8-018-0352	5" - 12,5 cm	0,4 x 0,25 mm	8-018-0354
8-018-0356		0,5 x 0,35 mm	8-018-0358
8-018-0360		0,7 x 0,55 mm	8-018-0362
8-018-0364		1,0 x 0,8 mm	8-018-0366
8-018-0368		1,2 x 0,9 mm	8-018-0370
8-018-0372		1,4 x 1,1 mm	8-018-0374

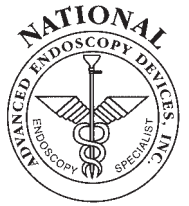

1/1

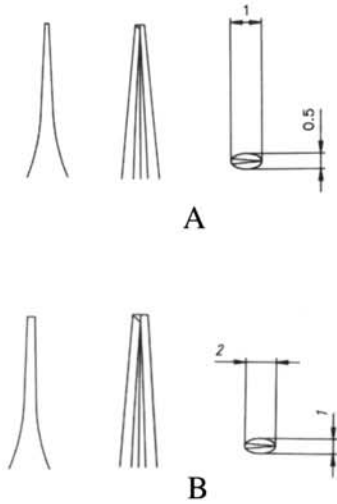

**ADSON
Tissue Forceps,
4³/₄" size, 1x2 Teeth**

A	8-018-061
B	8-018-060



1/1



**ADSON
Tissue Forceps,
4³/₄" size, serrated jaws**

A	8-018-065
B	8-018-066



1/1



**BROWN-ADSON
Tissue Forceps,
4³/₄", 7x7 side grasping
teeth**

straight	8-018-0700
angular	8-018-0701



1/1

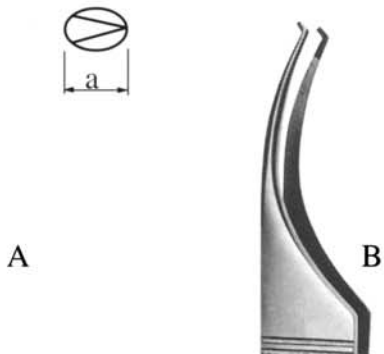

Colibri Type Tissue Forceps, 3", 1x2 teeth

	Code no	a	Code no	
A		0,12mm	80018-6298	B
	8-018-6300	0,25mm	8-018-6302	
	8-018-6304	0,4mm	8-018-6308	
	8-018-6310	0,6mm	8-018-6312	
	8-018-6314	0,8mm	8-018-6316	

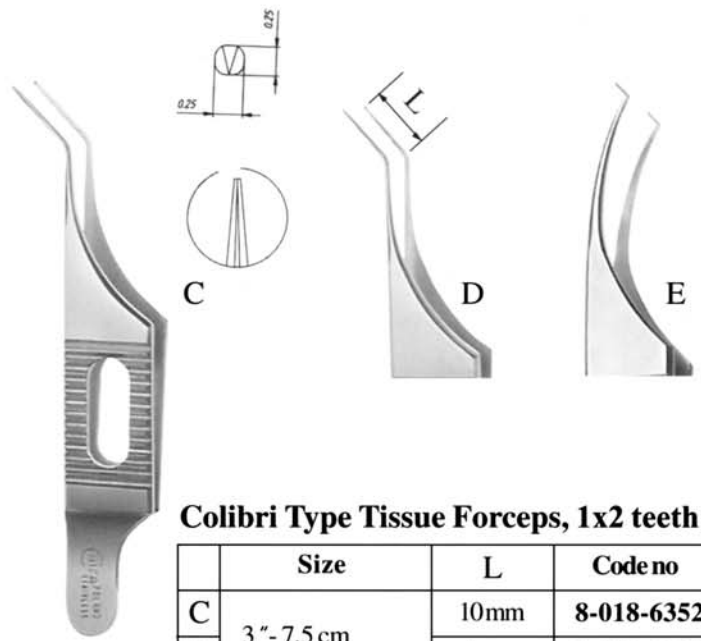

1/1

Colibri Type Tissue Forceps, 1x2 teeth

	Size	L	Code no
C	3"-7,5 cm	10mm	8-018-6352
D		8mm	8-018-6350
E	3 1/4" - 8 cm	2,5mm	8-018-6320

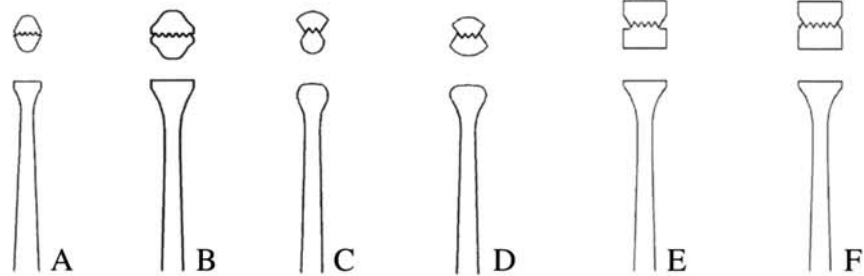

ALLIS Tissue Forceps

	Size	Teeth	Code no
A	5 1/8" - 13 cm	4x5	8-241-073
B	6" - 15 cm	5x6	8-241-043
C		2x3	8-241-0492
D		3x4	8-241-0493
E	6 1/8" - 15,5 cm	4x5	8-241-064
F		5x6	8-241-563

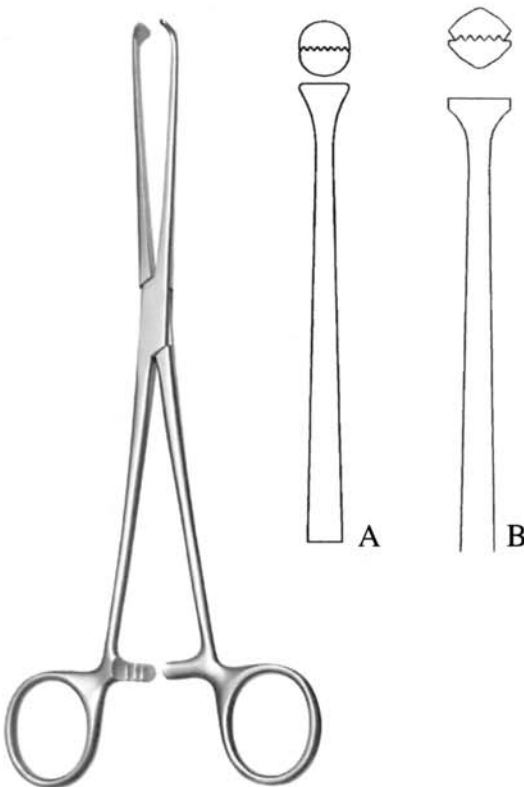

ALLIS

	Size	Teeth	Code no
A	8" - 20 cm	7x8	8-241-070
B	8 3/4" - 22 cm	5x6	8-241-071



**Intestinal Forceps,
jaws 8 mm wide**

Size	Code no
6" - 15 cm	8-241-065

**ALLIS Atraumatic Tissue
Forceps, jaws 6 mm wide**

Size	Code no
6" - 15 cm	8-241-050

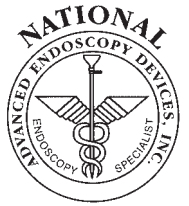

TUBING OCCLUDING FORCEPS

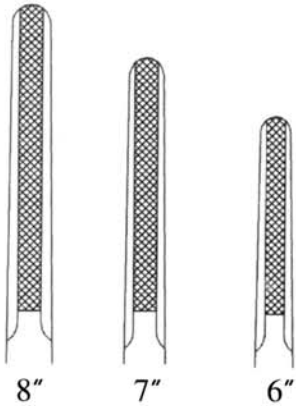

	Size	Code no
A	6" - 15 cm	8-101-011
B		8-101-011 G
A	7" - 18 cm	8-101-012
B		8-101-012 G
A	8" - 20 cm	8-101-013
B		8-101-013 G

This reliable range of tubing occluding forceps is designed for non-slip occlusion of silicone and p.v.c. tubing.

Available with and without safety guard. Tubing occluding forceps with safety guard are especially made to prevent the boxlock from puncturing the tubing.

Characteristics:
strong shanks for secure closing

A-standard

Special deep ratchets ensure safe occlusion

B-safety guard

Fine cross serrations prevent damage of tubes

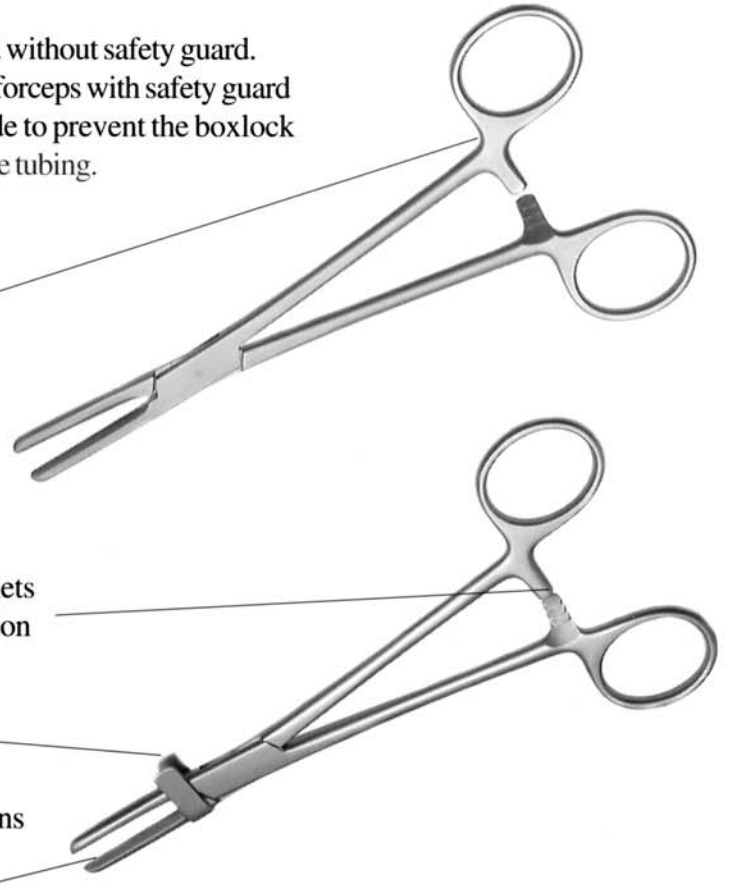

Tubing Clamp Forceps

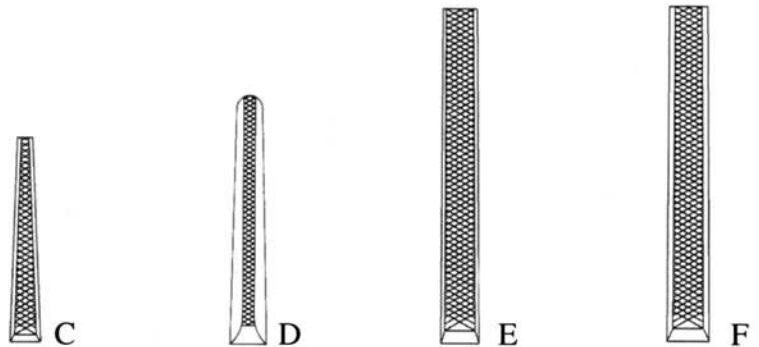

	Size	Code no
C	4 3/4" - 12 cm	8-104-512
D	6" - 15 cm	8-104-515
E	7" - 18 cm	8-104-518
F	8" - 20 cm	8-104-520

RETRACTORS AND TOWEL CLAMPS

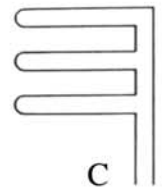
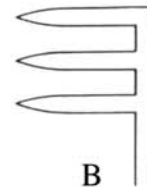
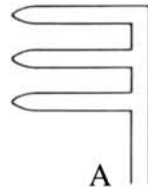

GELPI Self Retaining Retractors

Size	Code no
5 1/2" - 14 cm	8-136-851
7" - 18 cm	8-136-855



WEITLANER Self Retaining Retractors

	Size	Code no
A	5 1/4" - 13,5 cm	8-136-1351
B		8-136-1352
C		8-136-1353
A	6 1/2" - 16,5 cm	8-136-1651
B		8-136-1652
C		8-136-1653

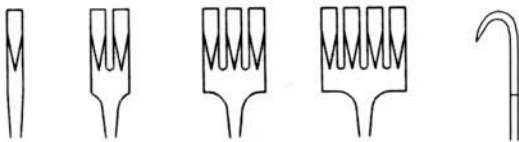

Flexible Neck Rake Retractors

Size		Code no
6 1/8" - 15,5 cm	2 sharp Prongs	8-136-9021
	3 sharp Prongs	8-136-9031
	4 sharp Prongs	8-136-9041

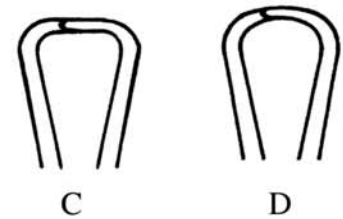
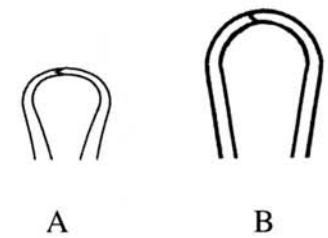

BACKHAUS Towel Clamps

	Size	Code no
A	3 1/2" - 9 cm	8-134-381
B	5 1/8" - 13 cm	8-134-383
C	5 1/4" - 13,5 cm	8-134-384
D	5 1/2" - 14 cm	8-134-385



Towel Clamps
Small model

Size	Code no
3 1/2" - 9 cm	8-132-344

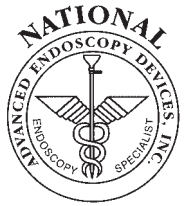

SCALPEL HANDLES AND SCALPEL BLADE REMOVERS



Scalpel Handles #3
For slot Blades

Size	Code no
4 ³ / ₄ " - 12 cm	8-102-143

1/1



Scalpel Handles #4
For slot Blades

Size	Code no
5 ¹ / ₈ " - 13 cm	8-103-144

1/1



Scalpel Handles

Size	Code no
4 ³ / ₄ " - 12 cm	8-100-066

1/1



Hard Blade Micro Braker and Holders

Size	Code no
4 ³ / ₄ " - 12 cm	8-100-5480

1/1



Instruments for Removing Scalpel Blades

Size	Code no
5 ¹ / ₄ " - 13,5 cm	8-100-513

SUTURE INSTRUMENTS AND SCISSORS



Clip Applying Forceps

Size	Code no
5" - 12,5 cm	8-036-125



**MICHEL Clip Applying
- Removing Forceps**

Size	Code no
4 ³ / ₄ " - 12 cm	8-036-135



**Clip Applying - Removing
Forceps**

Size	Code no
5 ¹ / ₄ " - 13,5 cm	8-036-143



Ligature Scissors

Size	Code no
4 ¹ / ₂ " - 11,5 cm	8-036-115



HUNTER Splinter Forceps

Size	Code no
4 ¹ / ₄ " - 11 cm	8-036-501

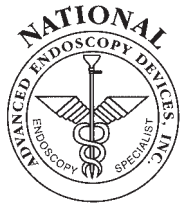

Micro Needle Holders, with round handle

Size	Code no
4 3/8"-11 cm	8-028-0131



Micro Scissors, flat handle, angled blades, blunt points

Size	Code no
4 3/8"-11 cm	8-025-0012



Micro Scissors, flat handle

	Size		Code no
A	4 3/8"-11 cm	sharp points	8-025-0041
B			8-025-0042
A	4 3/8"-11 cm	blunt points	8-025-0051
B			8-025-0052



Micro Scissors, flat handle, inner blade 0,5 mm longer, blunt tips

Size		Code no
4 3/8"-11 cm	left	8-025-0211
	right	8-025-0213



Micro Scissors, flat handle blunt tips

Size	Code no
4 3/8"-11 cm	8-028-0233



1/1

RUSKIN-LISTON
Bone Cutting Forceps,
Double Action

Size	Code no
7 1/2" - 19 cm	8-155-986



1/1

A



1/1

B



1/1

RUSKIN Bone Cutting Forceps
Double Action

	Size		Code no
A	5 3/4" - 14,5 cm	delicate	8-155-135
B			8-155-335

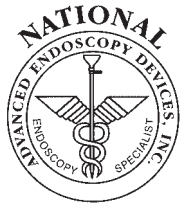

RONGEURS



RUSKIN Rongeurs, 3x14 mm bite

Size		Code no
6" - 15 cm	straight	8-187-857
	curved	8-187-858



RUSKIN Rongeurs

	Size	Bite	Code no
A	7 1/4" - 18,5 cm	4 x 15 mm	8-187-871
B			8-187-872
C		6 x 15 mm	8-187-875
D	8-187-876		



ZAUFAL-JANSEN

Size	Bite	Code no
7" - 18 cm	3 x 15 mm	8-182-180



BEYER

Size	Bite	Code no
7" - 18 cm	3 x 15 mm	8-181-170



ZAUFAL-JANSEN

Size	Bite	Code no
7" - 18 cm	4 x 15 mm	8-182-184



LEKSEL, angled on side

Size	Bite	Code no
9 1/2" - 24 cm	3 x 15 mm	8-186-155

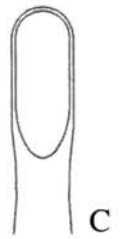
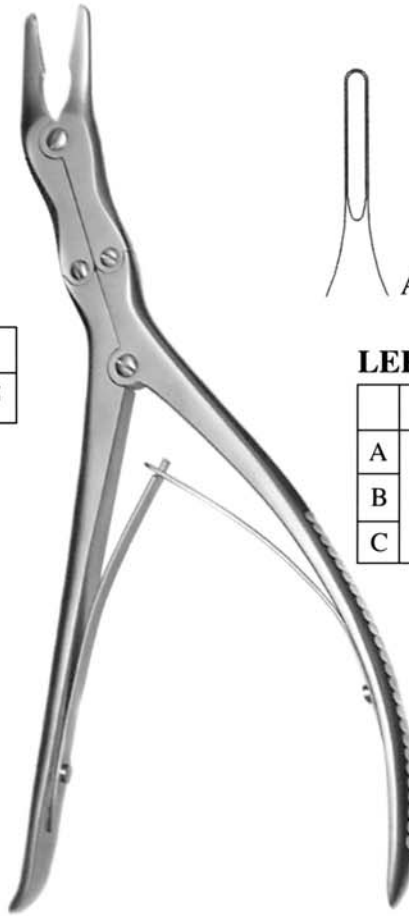

LEKSEL, slightly angled on side

	Size	Bite	Code no
A	10" - 25 cm	3 x 15 mm	8-186-243
B		5 x 15 mm	8-186-245
C		8 x 15 mm	8-186-248



RUSKIN-STILLE, Curved

Size	Bite	Code no
7" - 18 cm	4 x 14,5 mm	8-183-241



**ECHLIN Duckbill Rongeurs,
angled on side**

	Size	Bite	Code no
A	9" - 23 cm	2 x 10 mm	8-185-162
B		3 x 10 mm	8-185-003
C		4 x 10 mm	8-185-004

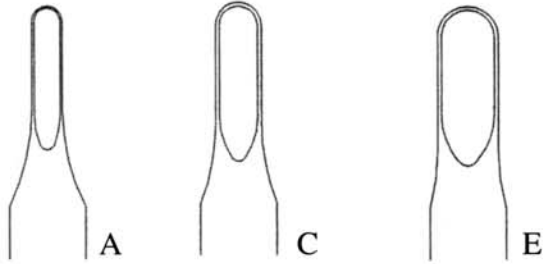
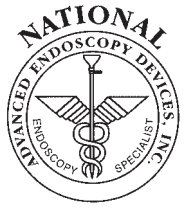

CUSHING, 7 1/2"

	Bite		Code no
A	4 x 12 mm	straight	8-187-981
B		angled	8-187-982
C	6 x 15 mm	straight	8-187-983
D		angled	8-187-984
E	8 x 15 mm	straight	8-187-985
F		angled	8-187-986

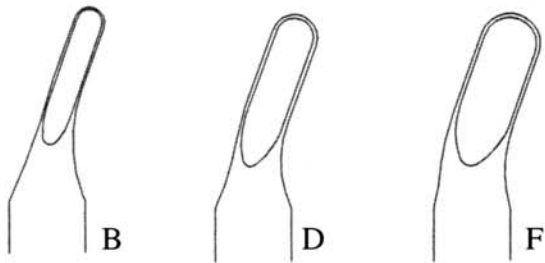
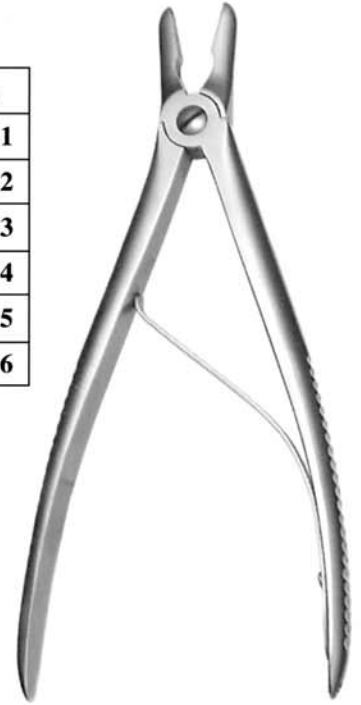

JANSEN-LUER

Size	Bite	Code no
7" - 18 cm	3,5 x 11 mm	8-187-487

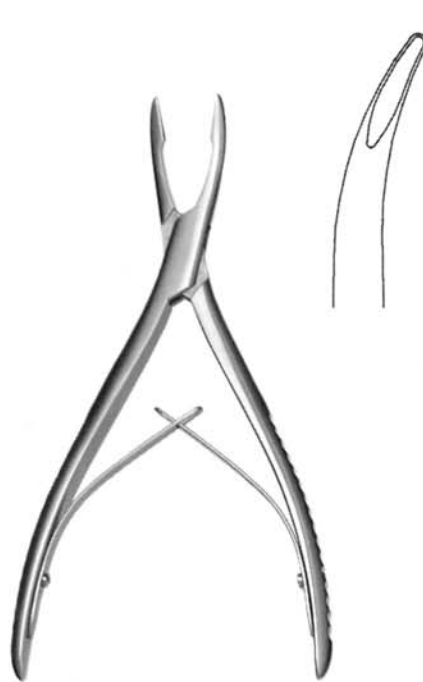

HAKANSSON-OLIVECRONA

Size	Bite	Code no
6 1/2" - 16,5 cm	2 x 12 mm	8-172-682

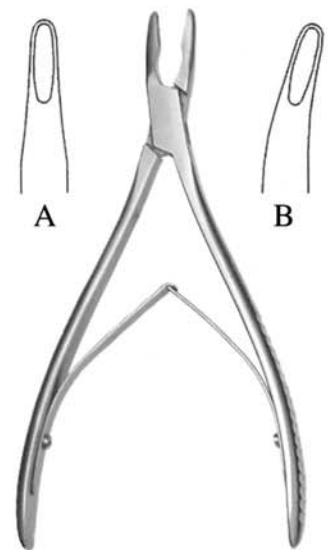

LEMPERT

	Size	Bite	Code no
A	6 1/8" - 15,5 cm	3 x 11 mm	8-187-311
B			8-187-312

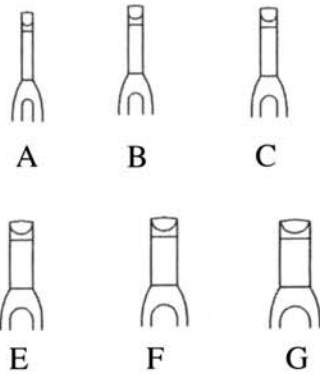

CITELLI Rongeurs, 5 3/4", Shaft 3 3/8"

	Size	Bite	Code no
A	1,5mm	3mm	8-184-015
B	2mm	3,5mm	8-184-020
C	2,2mm	3,5mm	8-184-022
D	2,5mm	3,8mm	8-184-025
E	3mm	4,5mm	8-184-030
F	3,5mm		8-184-035
G	4mm		8-184-040

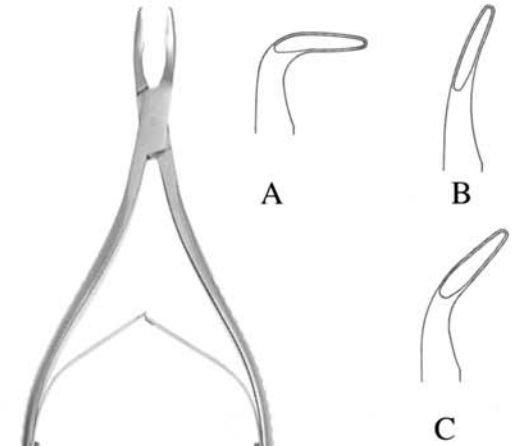

FRIEDMAN Rongeurs

	Size		Code no
A	5 1/2" - 14 cm	90°	8-187-981
B	6" - 15 cm	15°	8-187-982
C		45°	8-187-983

BONE HOLDING FORCEPS



FARABEU-F-LAMBOTTE

Size	Code no
10" - 25 cm	8-180-092



Small Bone Holding Forceps

Size	Code no
5 1/2" - 14 cm	8-180-023



**Bone Holding Forceps,
Serrated jaws**

Size	Code no
7 1/4" - 18,5 cm	8-180-024

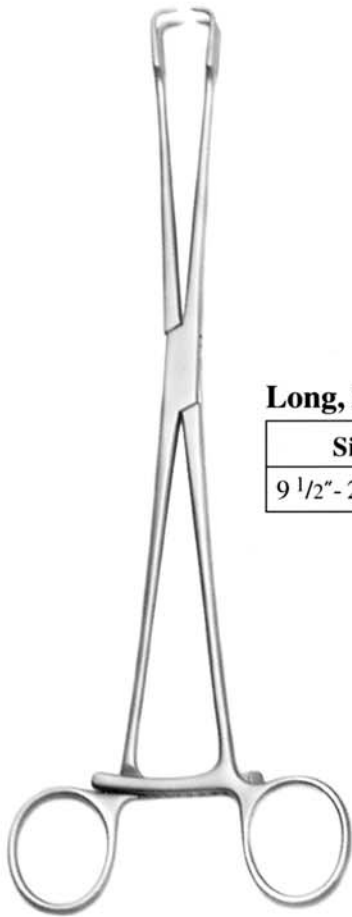
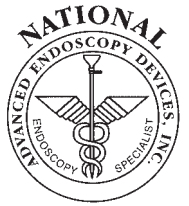

Long, 2x2 teeth

Size	Code no
9 1/2" - 24 cm	8-180-026

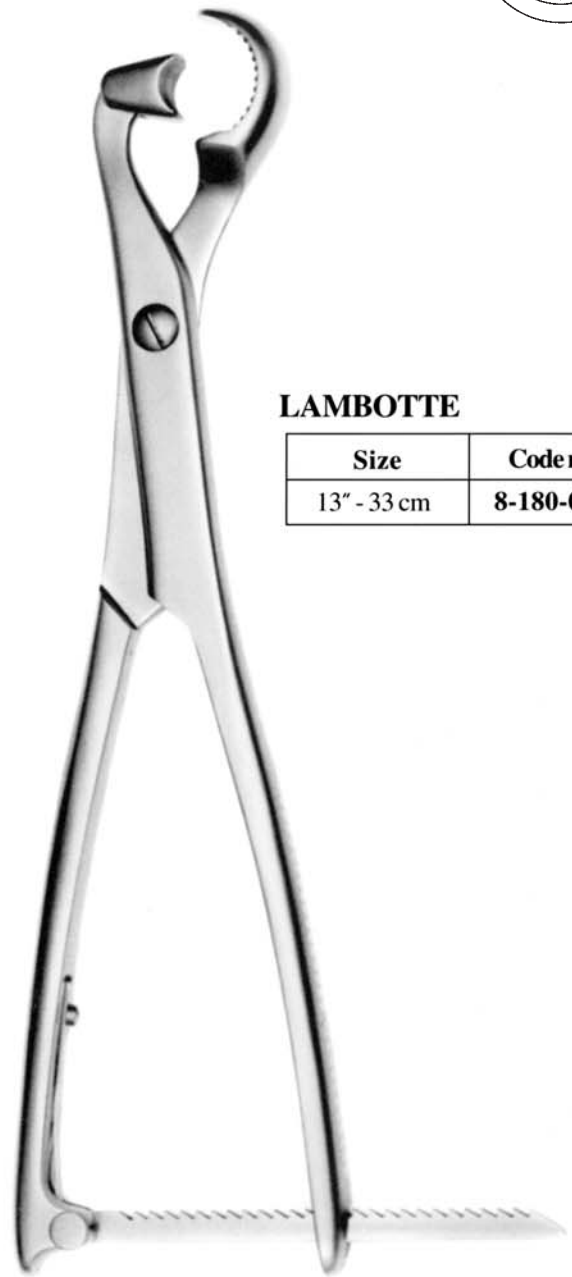

LAMBOTTE

Size	Code no
13" - 33 cm	8-180-033



LANGENBECK Elevators

Size	Code no
8" - 20 cm	8-143-051



FREER Septum Elevators

Double ended

Size	Code no
7" - 18 cm	8-224-133

BONE ELEVATORS

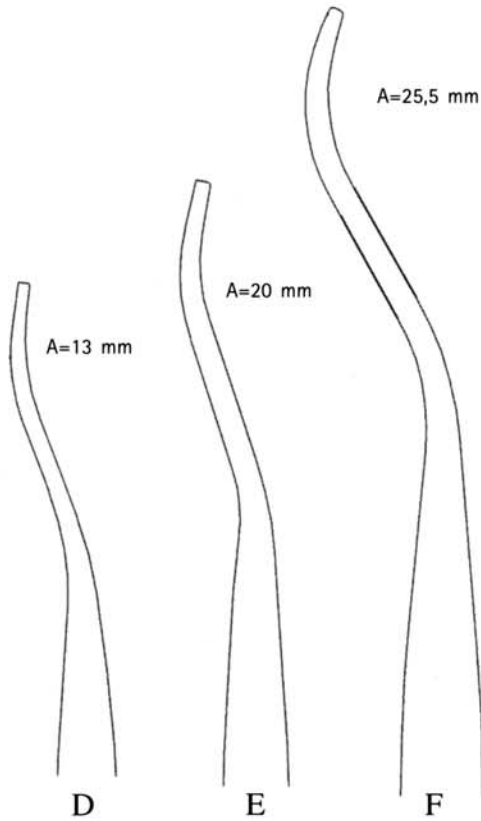

Elevators

	Size	A	Code no
D	5 1/2" - 14 cm	13mm	8-143-863
E	8" - 20 cm	20mm	8-143-864
F	9" - 23 cm	25,5mm	8-143-866

GOUGES, MALLETS

Gouges

	Size	Width	Code no
A	5 1/2" - 14 cm	3mm	8-147-853
B		4mm	8-147-854
C		5mm	8-147-855
D		6mm	8-147-856
	6 3/4" - 17 cm	3mm	8-147-863
		4mm	8-147-864
		5mm	8-147-865
		6mm	8-147-866



3 mm

4 mm

5 mm

6 mm

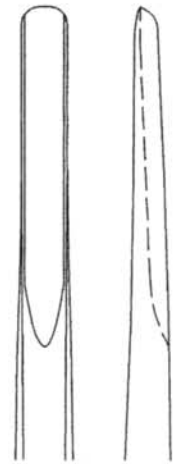
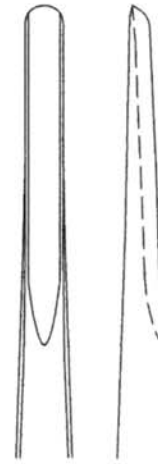
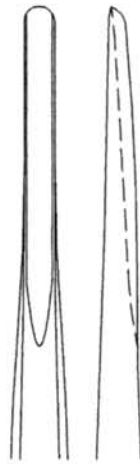
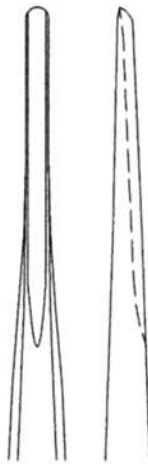

A

B

C

D

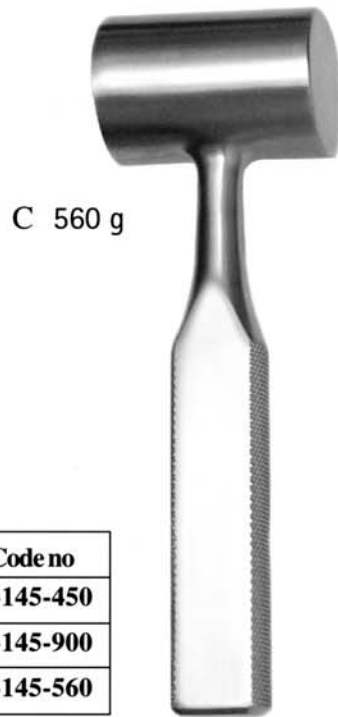
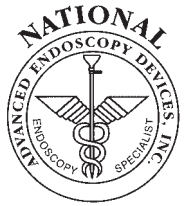

C 560 g

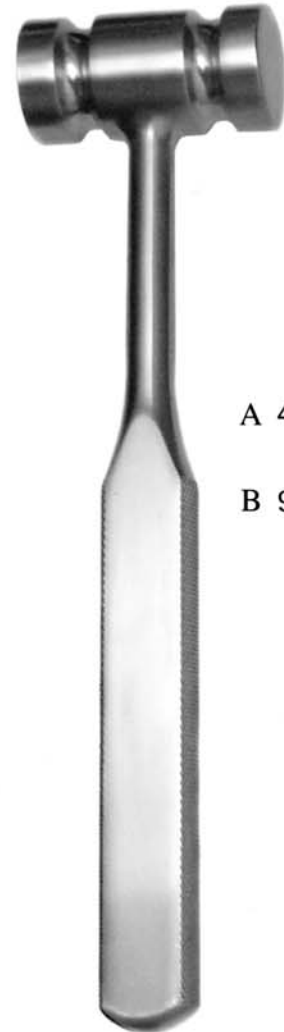

A 450 g

B 900 g

Mallets, solid stainless

	Size	Head	Code no
A	10 ³ / ₄ " - 27 cm	450 g	8-145-450
B		900 g	8-145-900
C	7 ¹ / ₄ " - 18,5 cm	560 g	8-145-560

BONE RASPS

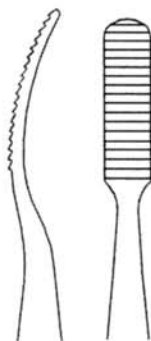

A

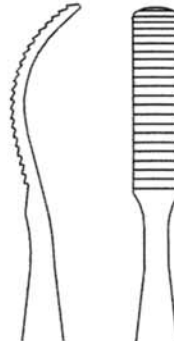

B

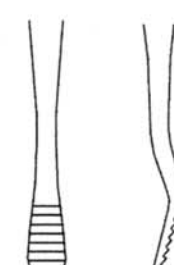

Double Ended Rasps

	Size	Code no
A	7" - 18 cm	8-148-183
B		8-148-185

Double Ended Rasps

Size	Code no
7" - 18 cm	8-148-181

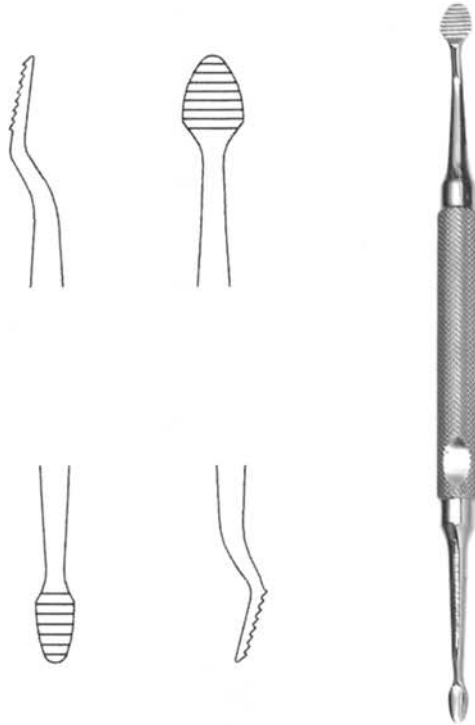

RETRACTORS

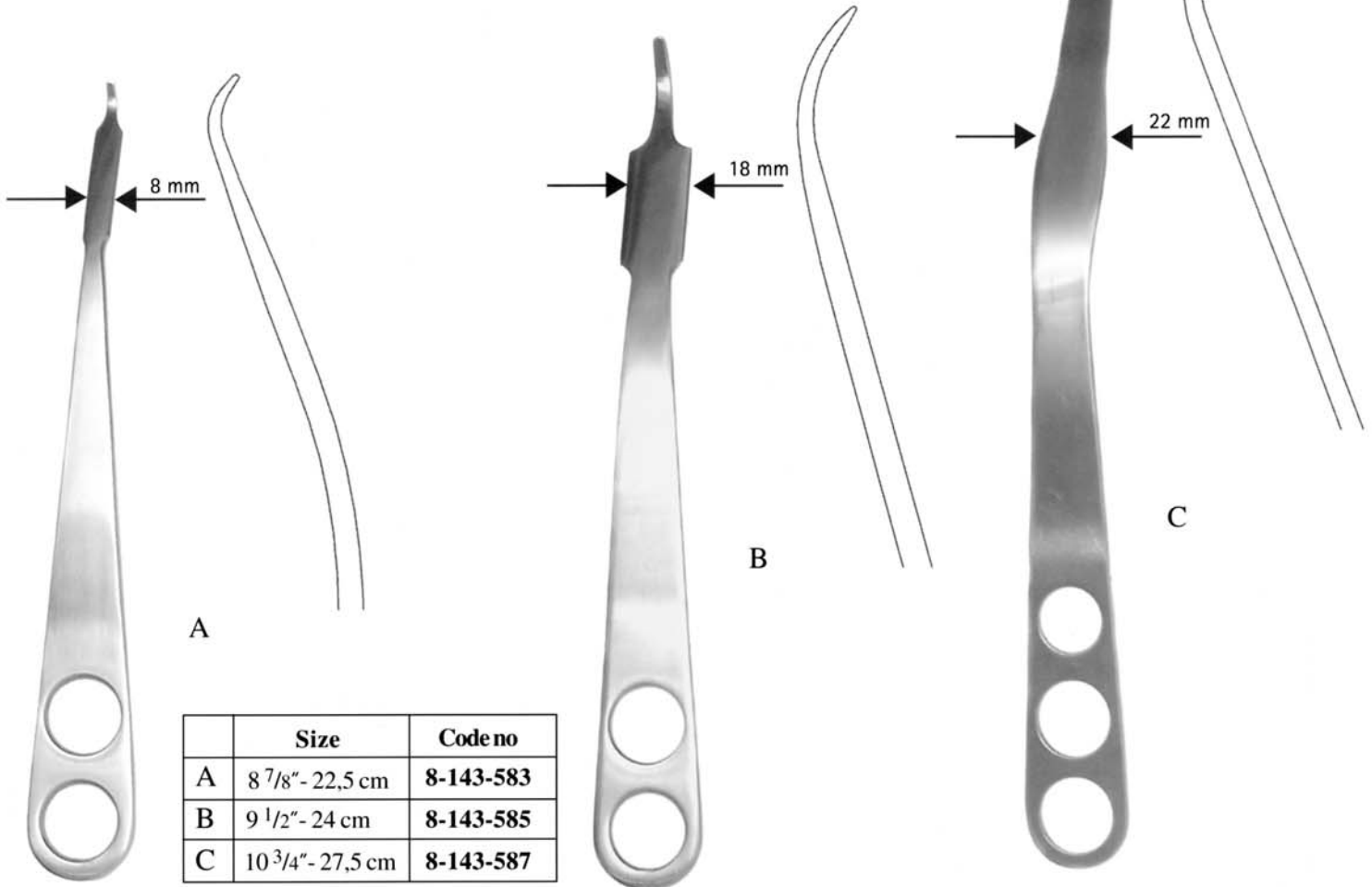

	Size	Code no
A	8 ⁷ / ₈ " - 22,5 cm	8-143-583
B	9 ¹ / ₂ " - 24 cm	8-143-585
C	10 ³ / ₄ " - 27,5 cm	8-143-587

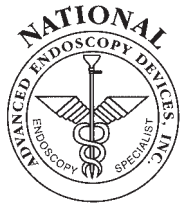

CURETTES

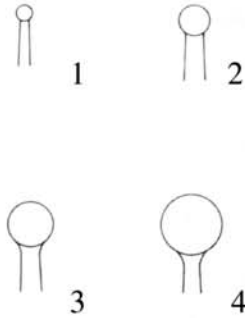

Bone Curettes
Round, Sharp, 7" - 18 cm

Size	Codeno
1-2 mm	8-137-721
2-4 mm	8-137-722
3-6 mm	8-137-723
4-6 mm	8-137-724

Note: Fig. 5-10 mm, 6-12 mm, 7-14 mm, 8-16 mm also available

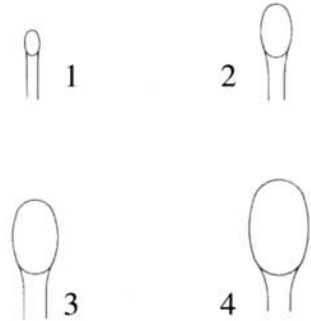

Bone Curettes
Oval, Sharp, 8 1/4" - 21 cm

Size	Code no
1-2 mm	8-138-751
2-4 mm	8-138-752
3-6 mm	8-138-753
4-8 mm	8-138-754

Note: Fig. 5-10 mm, 6-12 mm, 7-14 mm, 8-16 mm, 9-20 mm also available

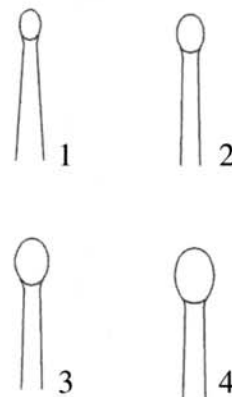

Bone Curettes
Angled, 8" - 20 cm

Size	Codeno
1-2,8 mm	8-138-828
2-3,6 mm	8-138-836
3-4,4 mm	8-138-844
4-5,2 mm	8-138-852

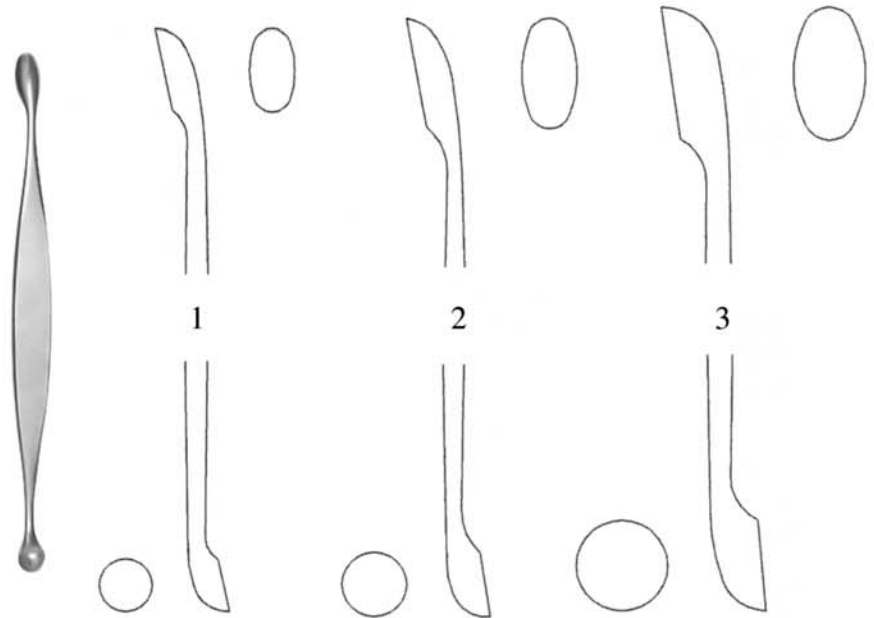

Bone Curettes Double Ended

	Size	Oval	Round	Code no
1	5 1/8" - 13 cm	6x11 mm	7mm	8-139-371
2	6 1/4" - 16 cm	7,3x14,5 mm	8,5 mm	8-139-372
3	8" - 20 cm	9,5x17,5 mm	12mm	8-139-373

WIRE AND PIN CUTTERS WITH TUNGSTEN CARBIDE INSERTS FOR CUTTING HARD WIRES, DOUBLE ACTION



Size	Code no
5 3/4" - 14,5 cm	8-603-091 H

for wire up to \varnothing 1,6 mm



Size	Code no
6 3/4" - 17 cm	8-135-470

for wire up to \varnothing 1,6 mm

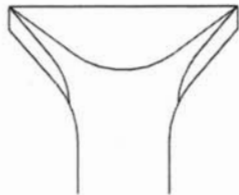

for wire up to \varnothing 2,5 mm

Size	Code no
8 1/2" - 21,5 cm	8-135-471



for wire up to \varnothing 2,2 mm

Size	Code no
9" - 23 cm	8-135-475



for wire up to \varnothing 2,2 mm

Size	Code no
9 1/4" - 23,5 cm	8-135-478

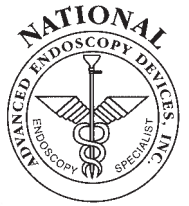

Pin End Cutters

Size	Code no
15" - 38 cm	8-161-472



for pins up to \varnothing 5 mm

Side Pin Cutters

Size	Code no
18 ³ / ₄ " - 47,5 cm	8-161-475

Note: Model with two-piece handles for smaller autoclaves also available - code no. 8-161-477



for pins up to \varnothing 6 mm



Wire Cutters

	Size	Wire	Code no
A	6" - 15 cm	up to \varnothing 1 mm	8-603-096 H
B	5 ¹ / ₂ " - 14 cm	up to \varnothing 1 mm	8-603-092 H



Delicate Wire Cutters with Safety Hold

Size	Wire	Code no
5 ¹ / ₈ " - 13 cm	up to \varnothing 0,4 mm	8-603-090 H

WIRE CUTTERS

WIRE PLIERS

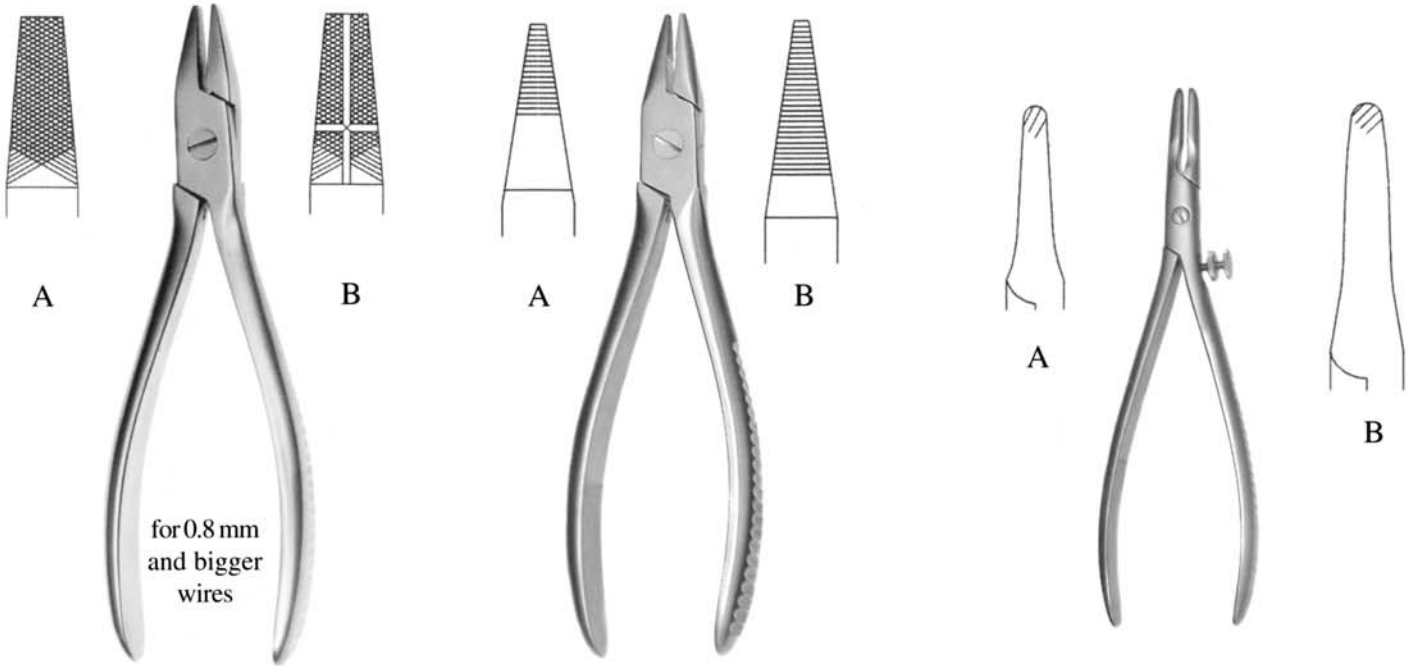

Pliers for Wire Removal

	Size	Code no
A	7" - 17,5 cm	8-161-208
B		8-161-210

Wire Pliers, parallel serration

	Size	Code no
A	7" - 17,5 cm	8-161-311
B	7 1/2" - 19 cm	8-161-312

Pin and Wire Pullers

	Size	Wire	Code no
A	5 1/2" - 14 cm	min. \varnothing 2 mm	8-161-140
B	7" - 18 cm	min. \varnothing 2 mm	8-161-180

WIRE AND PLATE SCISSORS



Crown Scissors, Smooth Edge

Size		Code no
4 3/4" - 12 cm	straight	8-604-046
	curved	8-604-047

Uniwersal Wire and Plate Scissor, One Blade Serrated (soft wire up to .03", plates .012")

Size	Code no
4 3/4" - 12 cm	8-604-002

WIRE TWISTERS



Delicate Wire twisters, T.C.

Size	Code no
5 1/2" - 14 cm	8-605-006 H
6 3/4" - 17 cm	8-605-007 H

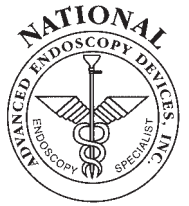

GENERAL UTILITY PLIERS



Flat Nose

Size		Code no
5 1/2" - 14 cm	serrated	8-601-018
	smooth	8-601-019
	with groove	8-601-020



A

B

Small Flat Nose

	Size		Code no
A	5 1/2" - 14 cm	serrated	8-601-006
B		smooth	8-601-007



GOSLEE, Flat Nose

Size	Code no
5 1/2" - 14 cm	8-604-008



Prolong Flat Nose

Size		Code no
5 1/2" - 14 cm	serrated	8-601-015
	smooth	8-601-016



Wide Flat Nose Pliers

Size		Code no
5 1/2" - 14 cm	serrated	8-601-001
	smooth	8-601-002



A

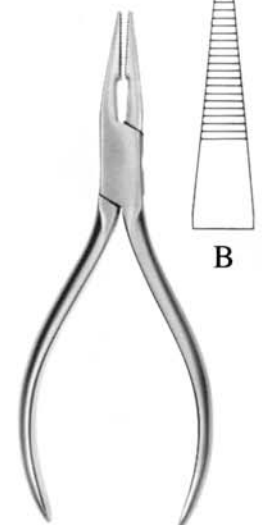

B

Flat Pliers, parallel serration

	Size	Code no
A	5 1/4" - 13,5 cm	8-601-005
B	5 3/4" - 14,5 cm	8-601-017

NAIL NIPPERS AND SCISSORS



**Nail Nippers, Double action,
barrel spring**

		Code no	Size
A	concave	8-301-372	6" - 15 cm
B	flat	8-301-375	

Cuticle Nippers, 2-Spring

Size	Code no
4 3/8" - 11 cm	8-301-116

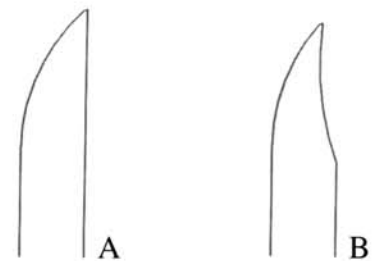
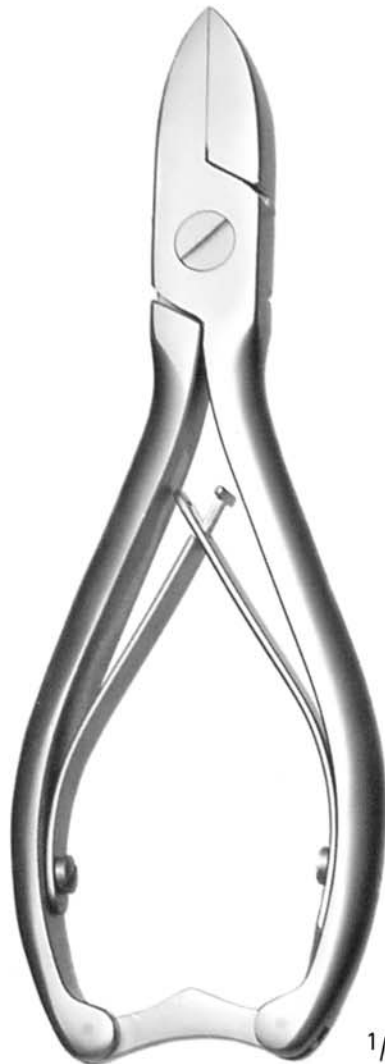
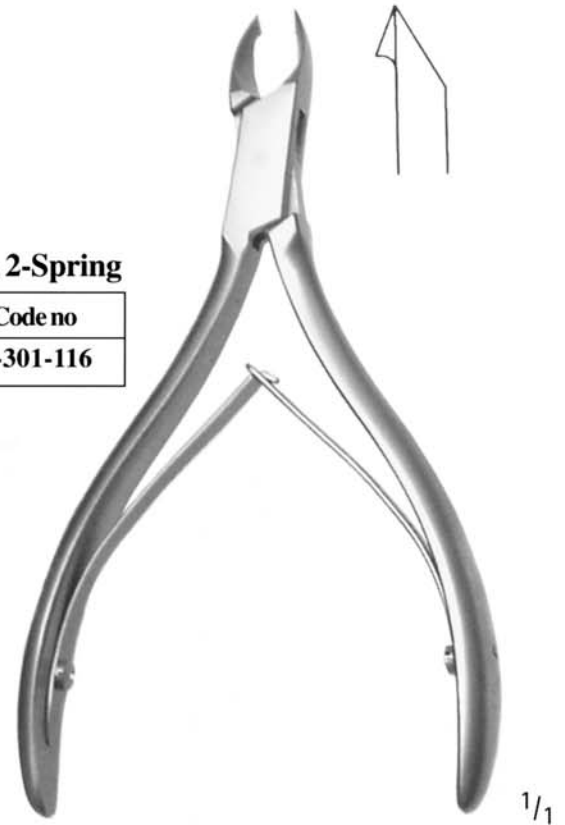

**Nail Nippers, Screw Joint,
2-Spring**

		Size	Code no
A	Flat	5 1/2" - 14 cm	8-301-143
B	Cvd		8-301-144

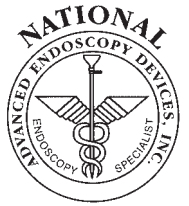

1/1

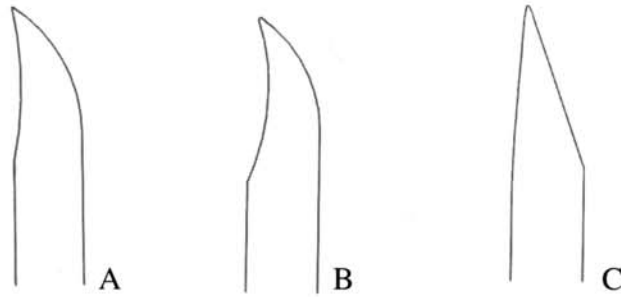

Nail Nippers, 2-Spring

		Code no	Size
A	delicate concave	8-301-147	5 1/2" - 14 cm
B	concave	8-301-148	
C	flat	8-301-149	



1/1



Nail Nippers, Concave Jaws

Size	Code no
5 1/4" - 13,5 cm	8-301-146

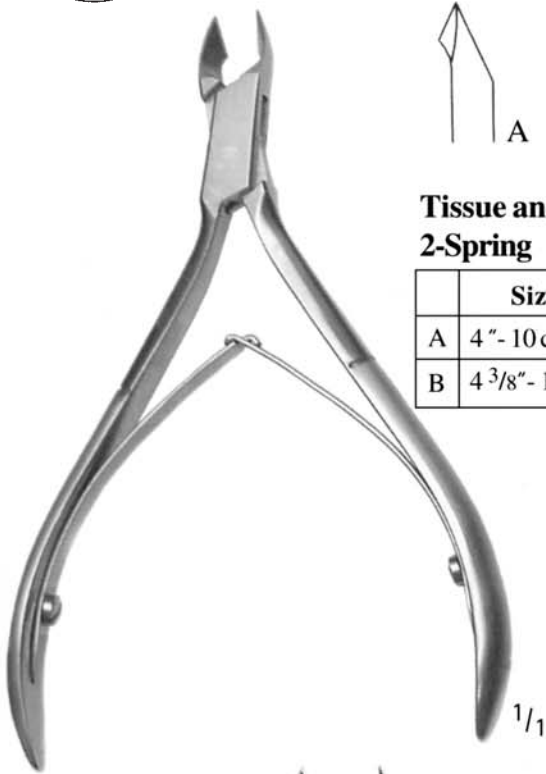

**Tissue and Cuticle Nippers,
2-Spring**

	Size	Code no	Blade
A	4" - 10 cm	8-301-106	5,5 mm
B	4 3/8" - 11 cm	8-301-111	10,5 mm

1/1

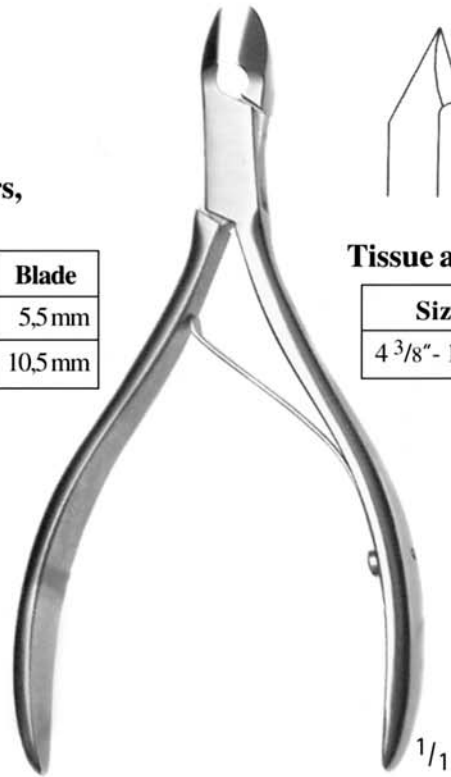

Tissue and Cuticle Nippers

Size	Code no
4 3/8" - 11 cm	8-301-118

1/1



**Double Spring Nail Nippers,
Concave Jaws, 2-Spring**

Size	Code no
5 1/4" - 13,5 cm	8-301-152

1/1

**Double Spring Nail Nippers,
Concave Jaws, 2-Spring**

Size	Code no
5 1/4" - 13,5 cm	8-301-150



1/1

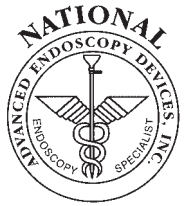

Tissue and Cuticle Nippers

Size	Code no
4 3/8" - 11 cm	8-301-119

1/1

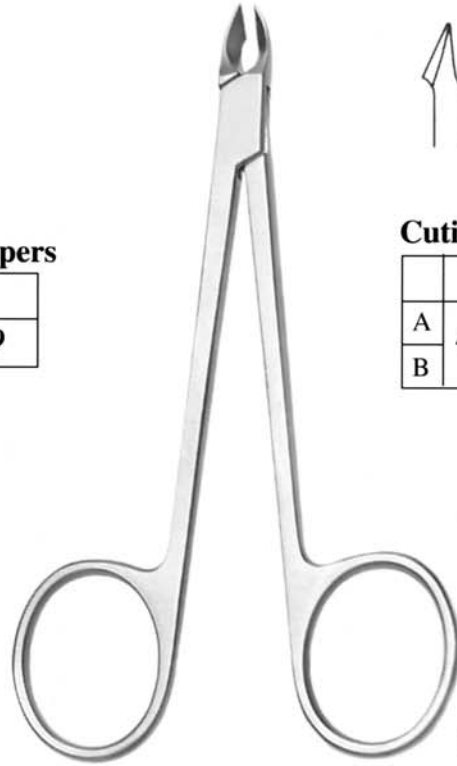

Cuticle Nippers

	Size	Code no
A	4" - 10 cm	8-301-137
B		8-301-139

1/1



1/1

Cuticle Nippers

Size	Code no
3 1/2" - 8,5 cm	8-301-133

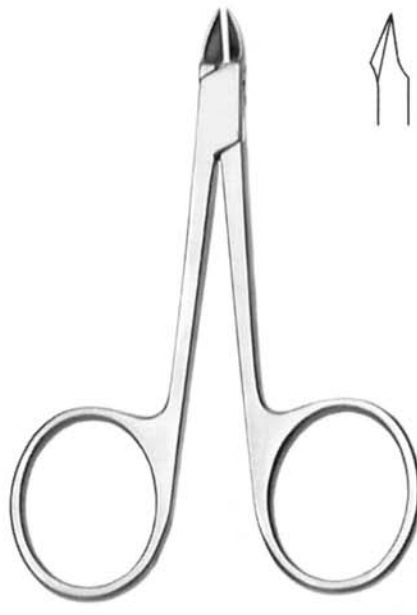

1/1

Cuticle Nippers

Size	Code no
3 1/4" - 8 cm	8-301-130



1/1

Nail Scissors, curved

Size	Code no
3 1/2" - 8,5 cm	8-302-383

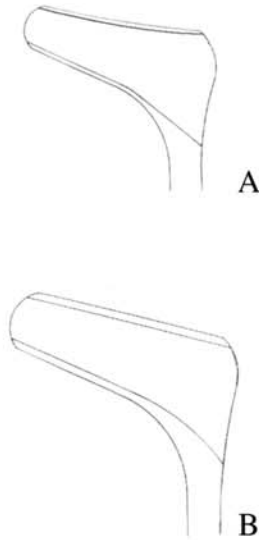

Nasal Speculums, with set screw

	Size		Code no
A	6 1/8" - 15,5 cm	6 x 27 mm	8-090-384
B	6 1/4" - 16 cm	8 x 32 mm	8-090-386



SCHROEDER Tenaculum Forceps, 2 x 2 teeth

Size	Code no
9 1/2" - 24 cm	8-265-186

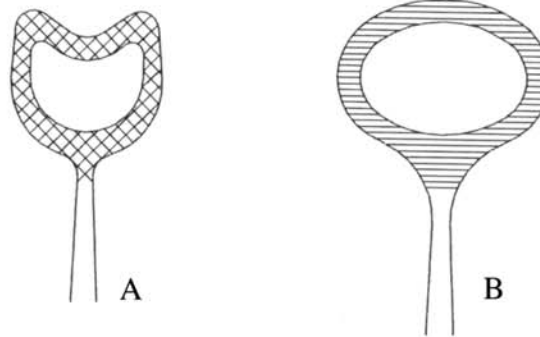

Tongue Seizing Forceps

	Size		Code no
A	5 1/2" - 14 cm	20mm	8-095-181
B	6 3/4" - 17 cm	28mm	8-095-183

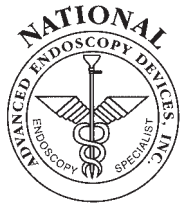

3-Prong Plaster Cast Spreaders

Size	Code no
8 3/4" - 22 cm	8-046-386



Plaster Nippers

Size	Code no
8 1/4" - 21 cm	8-046-200



LISTER Bandage Scissors

Size	Code no
5 3/4" - 14,5 cm	8-040-304
7" - 18 cm	8-040-305



ESMARCH Heavy Duty Bandage and Cast Shears

Size	Code no
8" - 20 cm	8-041-310



Scissors for left-handed, 5 3/4"

		Code no
straight	Sharp-Blunt	8-029-248
curved		8-029-250
straight	Blunt-Blunt	8-029-252
curved		8-029-254
straight	Sharp-Sharp	8-029-256
curved		8-029-258



Scissors for left-handed, Delicate

Size	Code no
str. 4 3/8" - 11 cm	8-029-587
cvd. 4 3/8" - 11 cm	8-029-588

LABORATORY FORCEPS



A

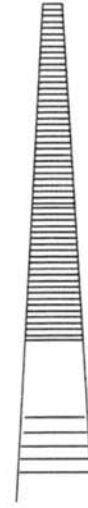

B

**High Quality S.S, Universal Laboratory Forceps
a. Wire Cutters (for soft wire up to .04")**

	Size		Code no
A	7" - 17,5 cm	Slim Nose	8-162-058
B	7 7/8" - 20 cm	Long Nose	8-162-059
C	6 1/2" - 16,5 cm	Square Nose	8-162-060
D	6" - 15 cm	Delicate Slim Nose	8-162-047

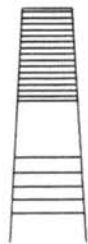

C

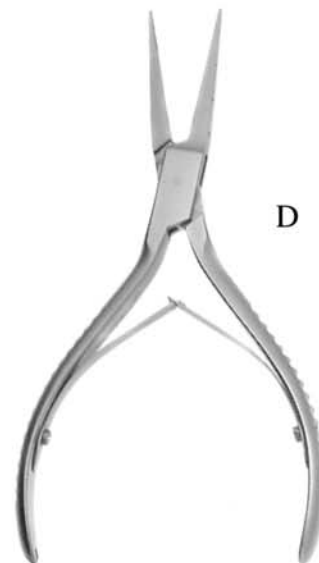

D

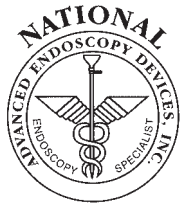

Features and Benefits:

- Patented design enables the Kerrison to be fully cleaned, thus, eliminating the build up of bone, tissue, and Bio burden that can cause sticking and or non-performance.
- Wide grip handles provides complete comfort and control.
- Single button makes ease of opening and closing.
- Bite size numbers are etched on both sides of kerrisons. Proven design provides a consistent smooth cutting action.
- Kerrison is manufactured completely from the highest grade German stainless steel.
- Made in Germany.

Sizes available

<u>Model #</u>	<u>Description</u>		
	<u>Bite Size</u>	<u>Length</u>	<u>Angle of Tip</u>
8527-00	1mm	x 180mm	x 40 Deg
8527-01	2mm	x 180mm	x 40 Deg.
8527-02	3mm	x 180mm	x 40 Deg.
8527-03	4mm	x 180mm	x 40 Deg.
8527-04	5mm	x 180mm	x 40 Deg.
8527-05	1mm	x 200mm	x 40 Deg.
8527-06	2mm	x 200mm	x 40 Deg.
8527-07	3mm	x 200mm	x 40 Deg
8527-08	4mm	x 200mm	x 40 Deg
8527-09	5mm	x 200mm	x 40 Deg
8527-10	1mm	x 180mm	x 90 Deg.
8527-11	2mm	x 180mm	x 90 Deg.
8527-12	3mm	x 180mm	x 90 Deg.
8527-13	4mm	x 180mm	x 90 Deg
8527-14	5mm	x 180mm	x 90 Deg
8527-15	1mm	x 200mm	x 90 Deg
8527-16	2mm	x 200mm	x 90 Deg.
8527-17	3mm	x 200mm	x 90 Deg
8527-18	4mm	x 200mm	x 90 Deg
8527-19	5mm	x 200mm	x 90 Deg.



Champion Kerrison

Features and Benefits:

- Universal Design
- MFG From 100% High Grade German Stainless Steel
- Unique Clean out Distal
- Bite Size numbers etched on both sides of kerrison
- Made In Germany



Model #	Description		
	Bite Size	Length	Angle of Tip
8530-00	1mm	x 180mm	x 40 Deg.
8530-01	2mm	x 180mm	x 40 Deg.
8530-02	3mm	x 180mm	x 40 Deg.
8530-03	4mm	x 180mm	x 40 Deg.
8530-04	5mm	x 180mm	x 40 Deg.
8530-05	1mm	x 200mm	x 40 Deg.
8530-06	2mm	x 200mm	x 40 Deg.
8530-07	3mm	x 200mm	x 40 Deg.
8530-08	4mm	x 200mm	x 40 Deg.
8530-09	5mm	x 200mm	x 40 Deg.
8530-10	1mm	x 180mm	x 90 Deg.
8530-11	2mm	x 180mm	x 90 Deg.
8530-12	3mm	x 180mm	x 90 Deg.
8530-13	4mm	x 180mm	x 90 Deg.
8530-14	5mm	x 180mm	x 90 Deg.
8530-15	1mm	x 200mm	x 90 Deg.
8530-16	2mm	x 200mm	x 90 Deg.
8530-17	3mm	x 200mm	x 90 Deg.
8530-18	4mm	x 200mm	x 90 Deg.
8530-19	5mm	x 200mm	x 90 Deg.



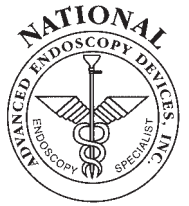

Features and Benefits

- Universal Design
- Harden Jaw For Consistent smooth cutting
- MFG in Germany From the Highest Grade German Stainless Steel



Model #	Description
8528-08	Kwik-Kleen Punch
8528-08-A	Kwik-Kleen Punch Jaw Shaft Only
8528-09	Ferris –Smooth Bone Ronguer
8528-10A	Tischler Punch – Jaw & Shaft Only
8528-12	Mini Punch
8528-13	Burke Punch
8528-14	Baby Tischler



Arthro - Pro

Features and Benefits

- Ergo Handle Design
- Mfg in Germany from 100 % High Grade-German Stainless Steel
- Large variety of Jaw Patterns
- Slim and Light weight handles
- Low profile punch jaws
- Performance Proven design
- Available in 2.7mm and 3.4mm Dia.
- Available in Vertical Angles – 7 Deg – 15 Deg Upturn
- Available in Horizontal Angles – 15 Deg -30 Deg – 45 Deg Right and Left



Jaw Patterns Available

Grasper
Spoon-Biopsy
Duckbill Punch
Low Profile Punch
Suction Punch

Side Biter
Back Biter
Scissor Punch
Scissor
Hook Punch

Contact Rep For specific model numbers and Ordering Information.

SAMPLE OF JAW PATTERNS



Grasper



Rt. Angle Punch



Axial Tooth Grasper



Stinger Back Biter



Scissor Punch



Duckbill Punch

ALPHABETICAL INDEX

ADSON Tissue Forceps	21	LANGENBECK Elevators	33
ALLIS Tissue Forceps	22	LEKSEL Rongeurs	30
BACKHAUS Towel Clamps	24	LEMPERT Rongeurs	31
BEYER Rongeurs	29	Ligature Scissors	26
Bone Curettes	37	LISTER Bandage Scissors	47
Bone Elevators	33, 34	LISTON Bone Cutting Forceps	27
Bone Holding Forceps	32, 33	Mallets	35
Bone Rasps	35, 36	MATHIEU Needle Holders	9
BOYNTON Needle Holders	10	MAYO Scissors	7
BROWN-ADSON Tissue Forceps	21	MAYO-HARRINGTON Scissors	7
Bulldog Clamps	17	MAYO-HEGAR Needle Holders	9
CASTROVIEJO Needle Holders	11	METZENBAUM Scissors	7, 8
CITELLI Rongeurs	32	Micro HALSTEAD Hemostatic Forceps	16
Clip Applying Forceps	26	Micro Needle Holders	11, 12
Clip Applying-Removing Forceps	26	Micro Scissors	12, 13
Colibri Type Tissue Forceps	21	Nail Nippers	42, 44
COOLEY Atraumatic Forceps	18, 19	Nail Scissors	45
CRILE Atraumatic Forceps	15	Nasal Speculums	46
Crown scissors	40	Needle Holders with Suture Scissors	10
CUSHING Rongeurs	31	NELSON Scissors	7
Cuticle Nippers	42-45	OLSEN-HEGAR Needle Holders	10
DE BAKEY Atraumatic Forceps	18, 19	PEAN Hemostatic Forceps	15
Delicate Forceps	20	Pin Cutters	39
Dressing Forceps	20	Pin and Wire Pullers	40
ECHLIN Duckbill Rongeurs	30	Plaster Cast Spreaders	47
ESMARCH Bandage and Cast Shears	47	Plaster Nippers	47
Eye Scissors	8	Retractors	36
FARABEUF-LAMBOTTE Bone Hold.Forceps .	32	ROCHESTER-PEAN Hemostatic Forceps	15, 16
Flexible Neck Rake Retractors	24	RUSKIN Bone Cutting Forceps	28
FREER Septum Elevators	33	RUSKIN Rongeurs	29
FRIEDMAN Rongeurs	32	RUSKIN-LISTON Bone Cutting Forceps	28
GELPI Retractors	24	RUSKIN-STILLE Rongeurs	30
General Utility Pliers	41	Scalpel Handles	25
Gouges	34	SCHROEDER Tenaculum Forceps	46
HAKANSSON-OLIVECRONA Rongeurs	31	Scissors for left-handed	47
HALSEY Needle Holders	10	Standard Operating Scissors	8
HALSTED Hemostatic Forceps	14, 16	Tissue Forceps	20-22
HALSTED-MOSQUITO Forceps	14	Tissue and Cuticle Nippers	42-45
HEISS Hemostatic Forceps	16	Tongue Seizing Forceps	46
HEGAR Needle Holders	10	Towel Clamps	24
HOEPFNER Hemostatic Forceps	16	Tubing Occluding and Clamp Forceps	23
HUNTER Splinter Forceps	26	WEBSTER Needle Holders	10
Instruments for Removing Scalpel Blades	25	WEITLANER Retractors	24
Intestinal Forceps	22	Wire and Plate Scissors	40
IRIS Scissors	8	Wire Cutters	39
JANSEN-LUER Rongeurs	31	Wire Cutters, Double Action	38
KELLY Hemostatic Forceps	14	Wire Pliers	40, 41
KOCHER Hemostatic Forceps	15	Wire Pullers	40
Laboratory S.S. Forceps	48	Wire Twisters	40
LAMBOTTE Bone Holding Forceps	33	ZAUFAL-JANSEN Rongeurs	29

ADVANCED ENDOSCOPY DEVICES, INC.

22134 Sherman Way

Canoga Park, CA 91303 • USA

Phone: (818) 227-2720

Fax: (818) 227-2724

www.aed.md