

S  
P  
E  
E  
D  
D  
L  
O  
C  
K<sup>®</sup>

# finest

INSTRUMENTS



# SPEEDLOCK®

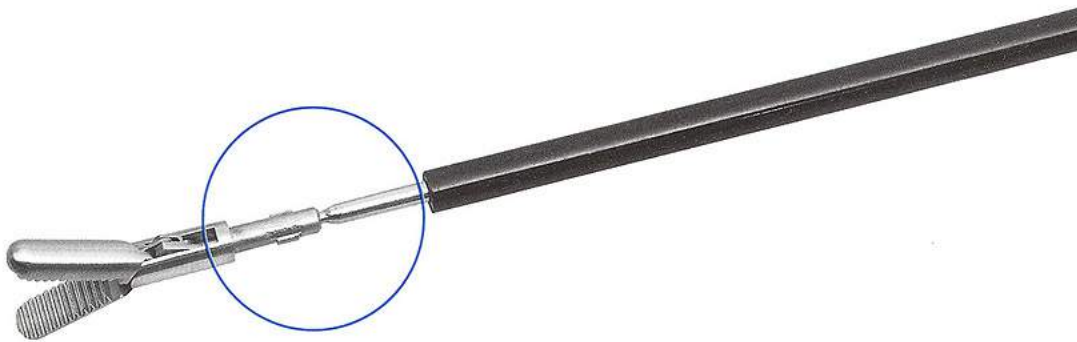

## Speedlock® - Laparoscopic Instruments

In terms of quality and handling these instruments surpass any other product line in the endoscopic market today. Some highlights include a cleaning port, which allows easy and time saving reprocessing, without taking the instruments apart. Jaw made out of a special stainless steel, making them even harder and better resistant against torque, tension and corrosion. The innovative new and unique bayonet coupling, makes assembly secure and so much easier.

Only an ongoing dialogue with users in combination with our almost 50 years experience and a continuous development have made this exceptional modular instrument line possible and that's why using SPEEDLOCK® means being one step ahead.

# SPEEDLOCK®

## SPEEDLOCK® instruments

- rotatable
- demountable (handle, sheath and insert)
- flushable
- with unique bayonet coupling
- stainless steel handles with internal insulation
- 45° handle-top HF-port
- cable protection
- length 36 cm and 45 cm - no problem with obese patients
- ergonomic handles in different styles for everybody's hand large and small
- 360° rotation, no increments to distort positioning
- no hidden spaces to accommodate blood and debris
- time saving – through easy cleaning and assembly
- highest durability, even if autoclaved
- cost effective - SPEEDLOCK® design reduces cost per case and inventory management
- virtually no stock if compared to disposable instruments
- environment – friendly due to its outstanding durability

# SPEEDLOCK®



<b>8512-00</b>	5 - 330 mm sheath	<b>8513-00</b>	10 - 330 mm sheath
<b>8512-01</b>	5 - 450 mm sheath	<b>8513-01</b>	10 - 450 mm sheath
<b>8512-02</b>	5 - 260 mm sheath	<b>8513-02</b>	10 - 260 mm sheath



**8510-02** French ratchet type handle, insulated



**8511-02** Carbon fibre reinforced, non conductive, safety handle



**8510-01** Carbon fibre reinforced, non conductive, safety handle, ratchet



**8511-01** Carbon fibre reinforced, non conductive, safety handle, ratchet



**8510-00** Carbon fibre reinforced, non conductive, safety handle



**8511-00** Carbon fibre reinforced, non conductive, safety handle, with ratchet

## GRASPING FORCEPS

Length	in stock	special	special
	330 mm	450 mm	260 mm
	8510-01	8510-03	8510-01-260 mm
			
	8510-05	8510-07	8510-005-260 mm
			
	8510-09	8510-11	8510-09-260 mm
			
	8510-13	8510-15	8510-03-260 mm
			
	8511-01	8511-03	8511-01-260mm
			
	8510-17	8510-19	8510-17-260 mm
			
	8511-05	8511-07	8511-05-260 mm
			
	8511-09	8511-11	8511-09-260 mm
			
	8511-13	8511-15	8511-13-260 mm
			

Tumor grasper, 5 mm, blunt end

Fenestrated grasping forceps, 5 mm, slightly flat jaws

Maxi type grasper, 5 mm, maximized grip

Strong grasper, 5 mm, toothed, crocojaw

Dissector, 5 mm, serrated, slightly curved version

Grasping forceps, 5 mm, rounded jaws

Dissector, 5 mm, serrated, strong curved version

Dissector straight, 5 mm, delicate serrated

Dissector curved, 5 mm, delicate serrated

## GRASPING FORCEPS, SCISSORS

Length	in stock	special	special
	330 mm	450 mm	260 mm
	8513-01	8513-02	8513-01-260 mm
	8510-21	8510-23	8510-21-260 mm
	8511-01	8511-03	8511-01-260 mm
	8512-05	8512-07	18512-05-260 mm
	8512-09	8512-11	8512-09-260 mm
	8510-26	8510-27	8510-26-260 mm
	8512-13	8512-15	8512-13-260 mm
	8512-17	8512-19	8512-17-260 mm
	8511-17	8511-19	8511-17-260 mm

Metzenbaum scissors, 5mm, curved, Slim Line version

Grasper, 5 mm, with spoon

Johan grasping forceps, 5 mm, slightly flat jaws

Johan grasping forceps, 5 mm, 22 mm slightly flat jaws

Johan grasping forceps, 5 mm, 38 mm slightly flat jaws







Grasper, 5 mm with spoon, pointed version

Kocher, 5 mm, 1x2 teeth

De Bakey, Maryland, curved, 5 mm version, atraumatic teeth

Maryland, 5 mm, cross serrations

## GRASPING FORCEPS

Length	in stock	special	special
	330 mm	450 mm	260 mm
	8512-32	8512-23	8512-21-260 mm
	8514-01	8514-03	8514-01-260 mm
	8514-05	8514-07	8514-05-260 mm
	8510-29	8510-31	8510-29-260 mm
	8514-09	8514-11	8514-09-260 mm
	8514-13	8514-15	8514-13-260 mm
	8514-17	8514-19	8514-17-260 mm
	8511-21	8511-23	8511-21-260 mm
	8514-21	8514-23	8514-21-260 mm

Endo Clinch, 5 mm, extremely atraumatic serrated

Strong atraumatic clamp, 10 mm, curved

Atraumatic grasper, 5 mm, single action

Sharp atraumatic grasper, 5 mm, single action

Strong atraumatic clamp, 10 mm, straight

T-shape atraumatic clamp, 10 mm, TC inserted jaws

Allis atraumatic clamp, 5 mm, TC inserted jaws

Alligator grasping forceps, 5 mm

Babcock atraumatic clamp, 10 mm, TC inserted jaws

## GRASPING FORCEPS

Length	in stock	special	special
	330 mm	450 mm	260 mm
	8514-25	8514-22	8514-25-260 mm
	8514-29	8514-31	8514-29-260 mm
	8514-33	8514-35	8514-33-260 mm
	8514-37	8514-39	8514-37-260 mm
	8514-41	8514-43	8514-41-260 mm
	8514-45	8514-47	8514-45-260 mm
	8514-49	8514-51	8514-49-260 mm
	8514-53	8514-55	8514-53-260 mm
	8514-57	8514-59	8514-57-260 mm

Atraumatic clamp, 5 mm, only cross serrated

Mixer, 5 mm, cross serrated

Mixer clamp, 10 mm, 45 degree angled, 10 mm

Reddick grasper, 5 mm

Mixer clamp, 10 mm, 90 degree angled

Allis grasping forceps, 5 mm rounded version

Glassmann atraumatic clamp, 5 mm

Maryland, 10 mm, cross serrations

Babcock, 10 mm



## GRASPING FORCEPS, SCISSORS

Length	In stock	special	special
	330 mm	450 mm	260 mm
	<b>8514-61</b>	<b>8514-63</b>	<b>8514-61-260 mm</b>
	<b>8513-03</b>	<b>8513-04</b>	<b>8513-03-260 mm</b>
	<b>8511-25</b>	<b>8511-27</b>	<b>8511-25-260 mm</b>
	<b>8513-05</b>	<b>8513-06</b>	<b>18513-05-260 mm</b>
	<b>8516-00</b>	<b>8516-02</b>	<b>8516-00-260 mm</b>
	<b>8514-65</b>	<b>8514-67</b>	<b>8514-65-260 mm</b>
	<b>8516-04</b>	<b>8516-06</b>	<b>8516-04-260 mm</b>
	<b>8510-33</b>	<b>18510-35</b>	<b>8510-33-260 mm</b>
	<b>8510-37</b>	<b>8510-39</b>	<b>8510-37-260 mm</b>

Fenestrated clamp, 5 mm

Microscissors, extremely delicate tip, shaft 5 mm, straight

Fenestrated dissector, 5 mm

Microscissors, extremely delicate tip, shaft 5 mm, curved

Needleholder, 5 mm, with TC inserts

Allis, 5 mm, single action, short version

Needleholder, 5 mm, with TC inserts

Standard grasper, 5 mm, cross serrated

Wave grasper DG, 5 mm with atraumatic wavelike serrations

## GRASPING FORCEPS

Length	In stock	special	special
	330 mm	450 mm	260 mm
	8514-69	8514-71	8514-69-260 mm
	8512-25	8512-27	8512-25-260 mm
	8512-29	8512-31	8512-29-260 mm
	8512-33	8512-35	8512-33-260 mm
	8512-37	8512-39	8512-37-260 mm
	8510-41	850-43	8510-41-260 mm
	8511-29	8511-31	8511-29-260 mm
	8511-33	8511-35	8511-33-260 mm
	8511-37	8511-39	8511-37-260 mm

Mixer clamp, 5 mm, 90 degree angled, long

Grasping forceps 5 mm serrated, atraumatic

Grasping forceps 10 mm serrated

Fenestrated grasping forceps, 5 mm, micro jaw

Retraction forceps with atraumatic inner teeth, 5 mm









Wave grasper DG, 5 mm with atraumatic wavelike serrations single action

Dolphin nose, 5 mm, short version









Maryland original model, 10 mm, diamond serrations

Maryland, 5 mm, diamond serrations

## GRASPING FORCEPS

Length	in stock	special	special	
	330 mm	450 mm	260 mm	
	8510-46	8510-47	8510-46-260 mm	Atraumatic grasper, 5 mm, diamond serrations
	8511-41	8511-43	8511-41-260 mm	Dolphin nose, 5 mm, long version
	8512-41	8512-43	8512-41-260 mm	Cobra style, 5 mm, toothed grasper
	8512-45	8512-47	8512-45-260 mm	Allis 5 mm 3 x 4 teeth, double action, atraumatic grasper
	8512-49	8512-51	8512-49-260 mm	Kelly forceps, 5 mm version
	8512-53	8512-55	8512-53-260 mm	Duckbill forceps, cross serrated, 5 mm
	8513-07	8513-08	8513-09-260 mm	Mini-Metzenbaum, 5 mm
	8513-09	8513-10	8513-09-260 mm	Metzenbaum, strong model, 5 mm

## SCISSORS

Length	in stock	special	special	
	330 mm	450 mm	260 mm	
	8513-11	8513-12	8513-11-260 mm	Hook scissors, 5 mm version
				
	8513-11DI	8513-12DI	8513-11DI-260 mm	Hook scissors, 5 mm version, disposable
				
	8513-13	8513-14	8513-13-260 mm	Hook scissors, 5 mm, sharp cutting edge
				
	8513-15	8513-16	8513-15-260 mm	Metzenbaum, 5 mm, straight
				
	8513-17	8513-18	8513-17-260 mm	Metzenbaum, 5 mm, curved
				
	8513-19	8513-20	8513-19-260 mm	Metzenbaum, 5 mm, straight, serrated
				
	8513-21	8513-22	8513-21-260 mm	Metzenbaum, 5 mm, curved, serrated
				
	8513-23	8513-24	8513-23-260 mm	Metzenbaum, 5 mm, curved, medium blades
				
	8513-25	8513-26	8513-25-260 mm	Peritoneal scissors, 5 mm, blunt tips
				

## PUNCHES

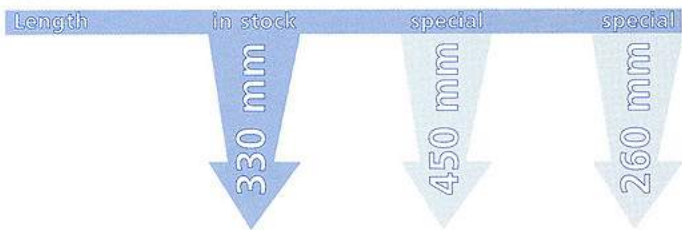

**8517-00**      **8517-01**      **8517-00-260 mm**

Biopsy punch, 5 mm, no tooth



**8517-02**      **8517-03**      **8517-02-260 mm**

Biopsy punch, 5 mm, with tooth



**8517-04**      **8517-05**      **8517-04-260 mm**

Biopsy spoon, 5 mm, single action version



**8517-06**      **8517-07**      **8517-06-260 mm**

Biopsy hook punch, 5 mm version

**13-1599A**      **13-1599-45A**      **13-1599-26A**

Anvil Grasper, 10 mm , reinforced version

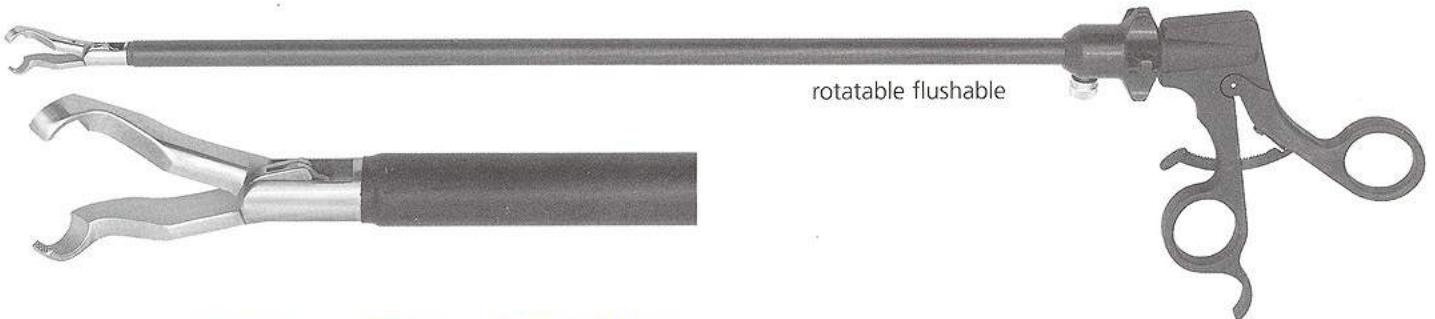

rotatable flushable



**8517-08**      **8517-09**      **8517-08-260 mm**

Biopsy spoon, 5 mm



**8517-10**      **8517-11**      **8517-10-260 mm**

Biopsy spoon, 5 mm, with spike

## PUNCHES, GRASPING FORCEPS



Allis, 10 mm, fine axial serrations

Allis, 5 mm, fine axial serrations

De Bakey, 10 mm, atraumatic serrations









De Bakey, 5 mm, atraumatic serrations

TC Allis, 10 mm, diamond serrations

TC Allis, 5 mm, diamond serrations

Tenaclum Forceps 10 mm

## GRASPING FORCEPS

Length	in stock	special	special	
	330 mm	450 mm	260 mm	
	8514-97	8514-99	8514-97-260 mm	Babcock, 10 mm
	8515-01	8515-03	8515-01-260 mm	Babcock, 5 mm
	8515-05	8515-07	8515-05-260 mm	Babcock - De Bakey, 5 mm
	8515-09	8515-11	8515-09-260 mm	Babcock, short version, for delicate applications, 5 mm
	8515-13	8515-15	8515-13-260 mm	US Babcock, with spring tension, flexible and atraumatic, 10 mm
	8515-17	8515-19	8515-17-260 mm	Babcock - De Bakey, 10 mm, atraumatic serrations
	8510-49	8510-51	8510-49-260 mm	Wave Grasper pointed version, conical, 5 mm
	8510-53	8510-55	8510-53-260 mm	Wave Grasper pointed version, flat, 5 mm

## GRASPING FORCEPS



Wave Grasper wide version, 5 mm

Kocher 10 mm, axial serrations, 40 mm jaws

Kocher 10 mm, axial serrations, 60 mm jaws

De Bakey, 10 mm, 40 mm long jaws

De Bakey, 10 mm, 60 mm long jaws

De Bakey, 5 mm, 40 mm jaws

Duval, 10 mm, with axial serrations, 40 mm jaws

TC Collin, 10 mm, with 30 mm jaws



## GRASPING FORCEPS

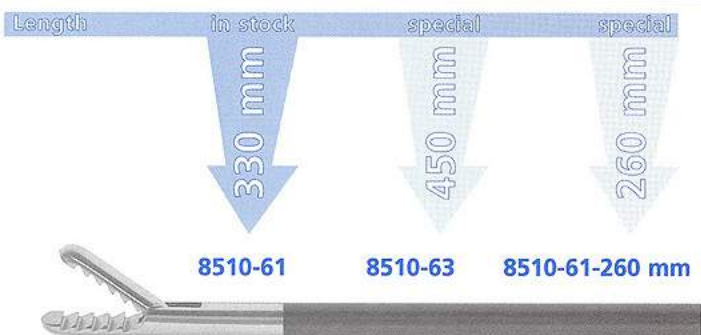

Alligator grasper, 5 mm, single action version



Claw forceps, 10 mm shaft, traumatic jaws



Claw forceps, 5 mm shaft, traumatic jaws



Large OP-scissors, 10 mm, blade serrated



Large spoon forceps, 10 mm shaft diameter



Metzenbaum scissors with 10 mm shaft

## NEEDLE HOLDERS

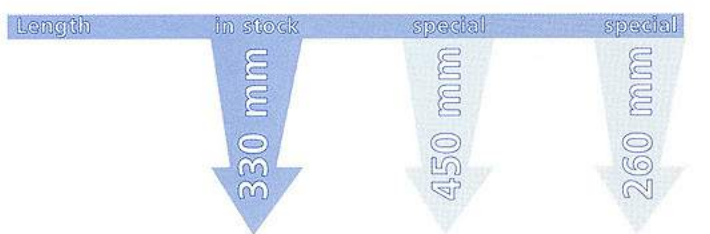

Needleholder pointed version, 5 mm, 10 mm jaw length



Needleholder pointed version, 5 mm, 8 mm jaw length

# TC NEEDLE HOLDERS



13-1592

Needleholder, cleaning port, fail-safe, axial handles, 5 mm



13-1593

Needleholder, cleaning port, fail-safe, axial handles, 5 mm



13-1594

Needleholder, cleaning port, fail-safe, axial handles, 5 mm

# MERTIE

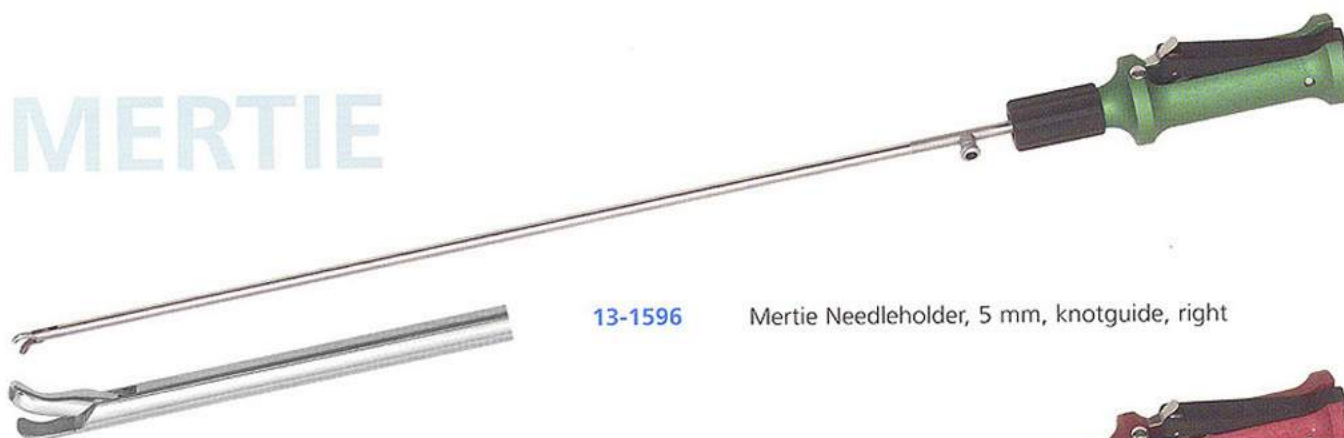

13-1596

Mertie Needleholder, 5 mm, knotguide, right

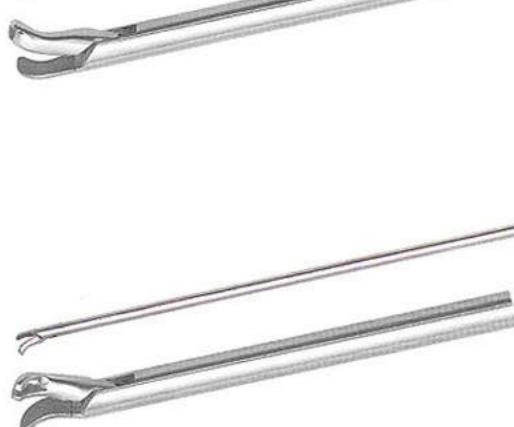

13-1597

Mertie Needleholder, 5 mm, knotguide, left

13-1598

Mertie Needleholder, 3 mm, without knotguide, straight

# CLIP APPLICATORS



**13-1610** Clip applicator for medium clips, 10 mm



**13-1615** Clip applicator for medium large clips, 10 mm



**13-1616** Clip applicator for LT 300 clips

## KNOT PUSHER

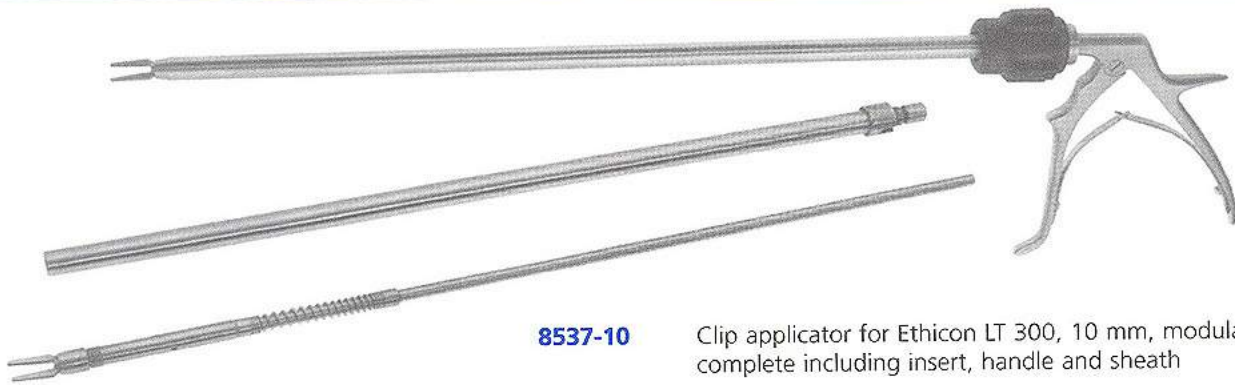

**8537-10** Clip applicator for Ethicon LT 300, 10 mm, modular, complete including insert, handle and sheath

**8537-11** Clip applicator for Weck Pilling medium, 10 mm, modular, complete including insert, handle and sheath

**8537-12** Clip applicator for Weck Pilling medium-large, 10 mm, modular, complete including insert, handle and sheath

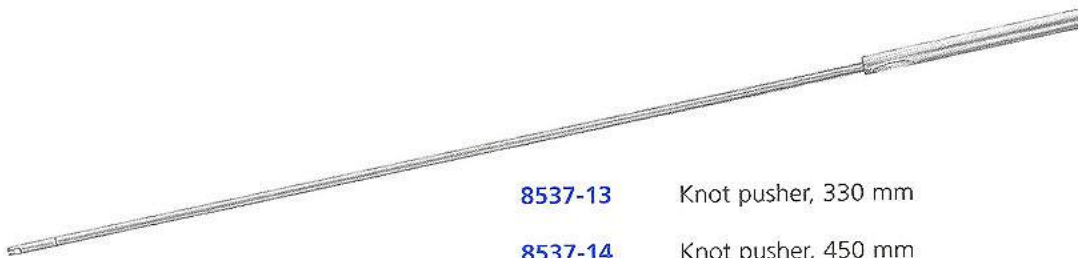

**8537-13** Knot pusher, 330 mm

**8537-14** Knot pusher, 450 mm



**8537-15** Knot pusher, 260 mm

**8537-16** Knot pusher, 330 mm with slot



**8537-17** Ring applicator 6 mm, for OP laparoscope, 380 mm long

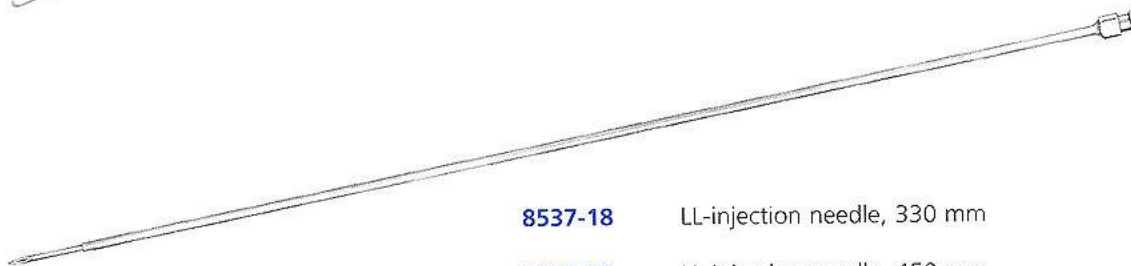

**8537-18** LL-injection needle, 330 mm

**8537-19** LL-injection needle, 450 mm

**8537-20** LL-injection needle, 260 mm

# PEDIATRIE PEDIATRY

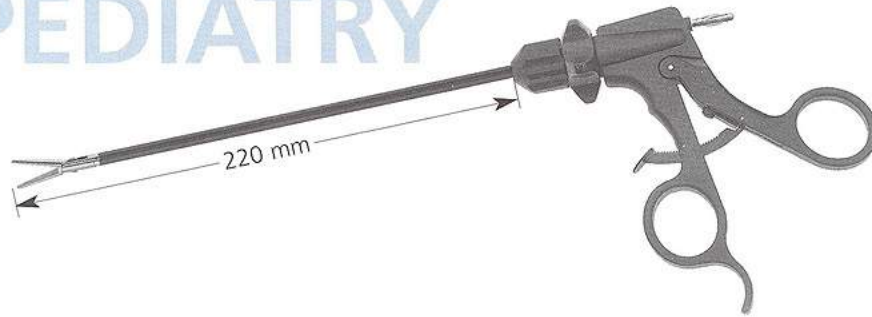

**8537-01**

Micro dissecting scissors, 5 mm



**8537-02**

Metzenbaum scissors, serrated 5 mm



**8537-03**

Maryland, dissecting forceps 5 mm



**8537-05**

Atraumatic grasper, 5 mm



**8537-07**

Biopsy punch, 5 mm



**8537-08**

Hook electrode



**8537-09**

J-Hook electrode

## THORACOSCOPY

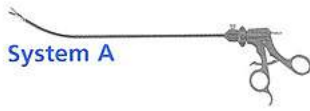

# THORACOSCOPY

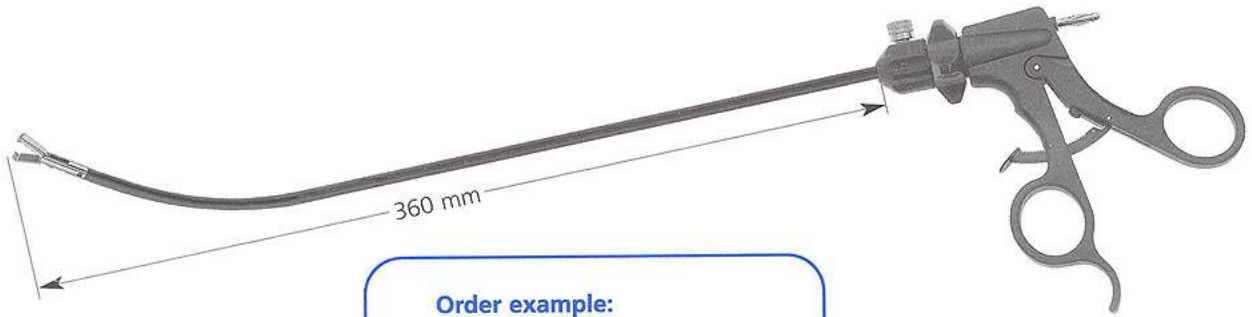

**Order example:**

13-1612 A  
13-1612 AR = Ratchet

13-1612 AAX  
13-1612 AAXR = Ratchet

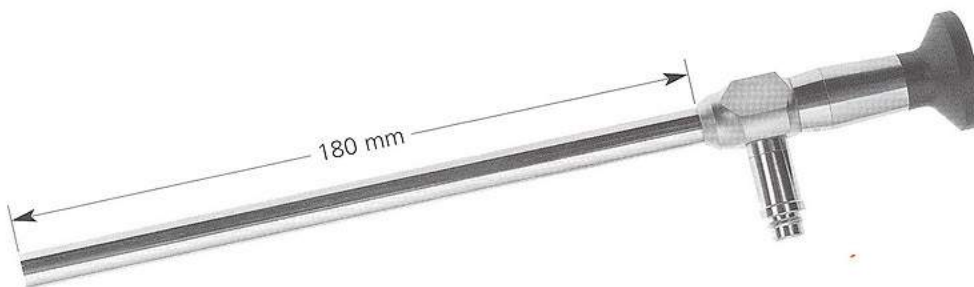
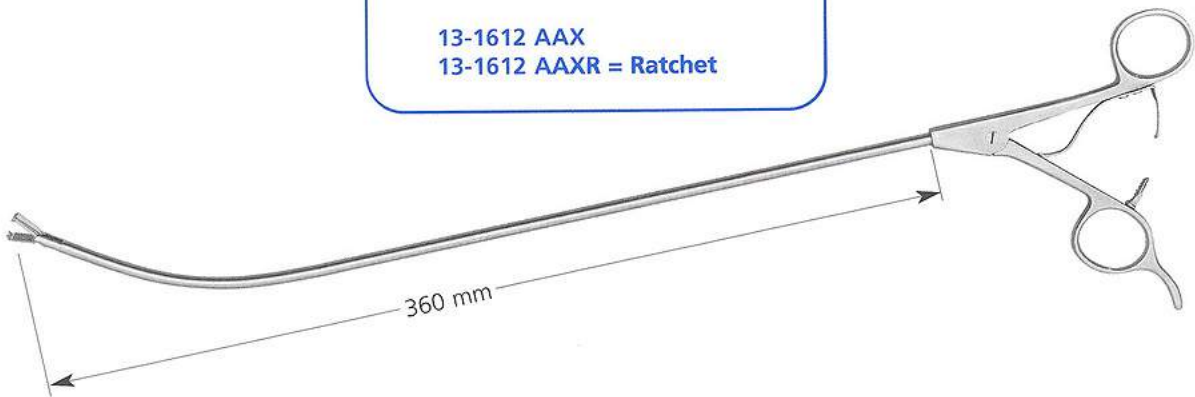

Autoclavable A 134 C

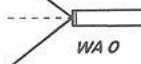

11-1130-180 Thoracoscope 10 mm 0 degree

Autoclavable A 134 C



11-1135-180 Thoracoscope 10 mm 30 degree

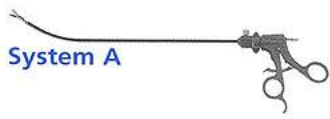

# THORACOSCOPY











- 13-1612** Crocodile grasper
- 13-1620** Micro forceps, 5 mm, extremely delicate tips
- 13-1621** Allis forceps angled, 5 mm
- 13-1622** Biopsy spoon, angled 5 mm
- 13-1623** Hook electrode with angled sheath
- 13-1624** Electrode with angled sheath
- 13-1625** Alligator grasper, 5 mm version
- 13-1626** Electrode J-hook form, angled





# THORACOSCOPY

	<b>13-1651</b>	Metzenbaum, angled sheath, 5 mm
	<b>13-1652</b>	Peritoneal scissors, angled sheath, 5 mm
	<b>13-1653</b>	Micro scissors, angled sheath, 5 mm
	<b>13-1654</b>	Cobra, toothed grasper, angled sheath, 5 mm
	<b>13-1656</b>	Atraumatic grasper, angled, 5 mm
	<b>13-1657</b>	Babcock-Allis, angled, 5 mm
	<b>13-1658</b>	Duval, angled, 10 mm
	<b>13-1659</b>	Grasping forceps, angled, 5 mm



# THORACOSCOPY



13-1661

Maryland, angled, 5 mm

13-1662

Atraumatic grasper, 5 mm angled

13-1663

Kocher, clamping forceps, angled 10 mm

13-1676

Crocodile grasper, 5 mm

30-3540

Needleholder, Ø 5 mm, ratchet

# THORACOSCOPY TROCARS

Obturator are always included in thoracoscopy trocars

## RIGID



**13-1627** Thoracoscopy trocar, 5,5 mm diameter

**13-1628** Thoracoscopy trocar, 7,0 mm diameter

**13-1631** Thoracoscopy trocar, 11,0 mm diameter

## FLEXIBLE



**13-1627FF** Thoracoscopy trocar, 5,5 mm diameter, **flexible**

**13-1631FF** Thoracoscopy trocar, 11,0 mm diameter, **flexible**

# FAN RETRACTORS



**13-1669** Hourlay Fan retractor, Ø 10 mm

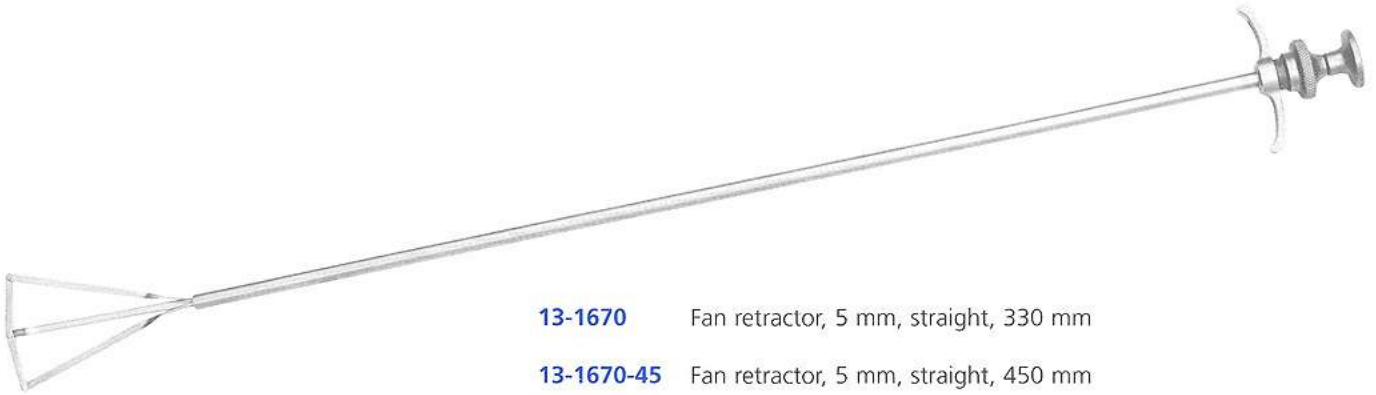

**13-1670** Fan retractor, 5 mm, straight, 330 mm

**13-1670-45** Fan retractor, 5 mm, straight, 450 mm

**13-1670-26** Fan retractor, 5 mm, straight, 260 mm

**13-1675** Fan retractor, 5 mm, curved, 330 mm

**13-1675-45** Fan retractor, 5 mm, curved, 450 mm

**13-1675-26** Fan retractor, 5 mm, curved, 260 mm

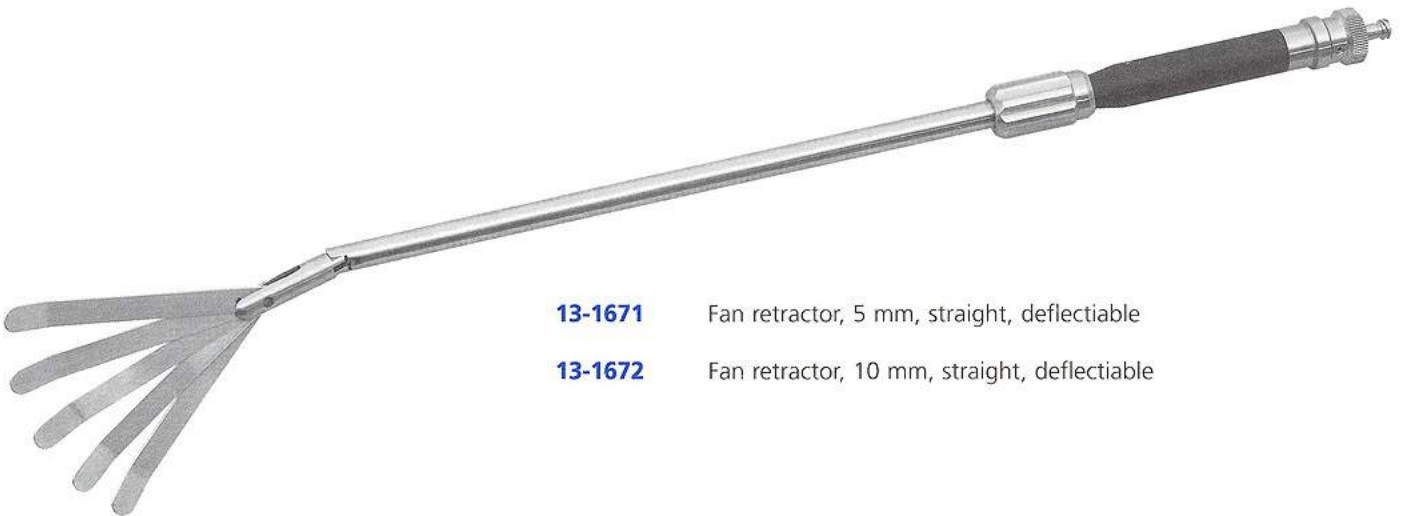

**13-1671** Fan retractor, 5 mm, straight, deflectable

**13-1672** Fan retractor, 10 mm, straight, deflectable

# BIPOLAR COAGULATION FORCEPS

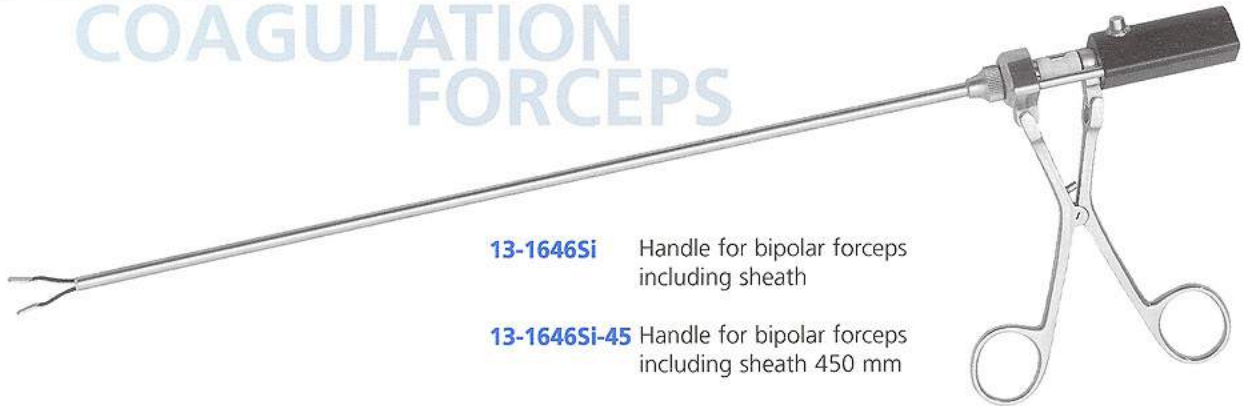

**13-1646Si** Handle for bipolar forceps including sheath

**13-1646Si-45** Handle for bipolar forceps including sheath 450 mm

## Inserts



**13-1630iW** Bipolar insert



**13-1633iW** Bipolar insert, scissors



**13-1634iWo** Bipolar insert, wide jaw, Kleppeninger



**13-1635iWo** Bipolar insert, wide jaw



**13-1640iW** Bipolar insert, micro tip



**13-1642iW** Bipolar insert, without nose

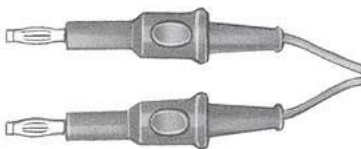

**13-1641BPW** Bipolar cable for US-Generators



**13-1643BPW** Bipolar cable for Erbe Generators



**13-1644BPW** Bipolar cable for Martin / Berchtold Generators

## BIPOLAR FORCEPS AND ACCESSORIES

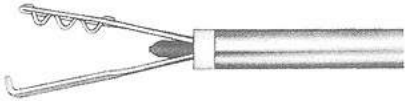
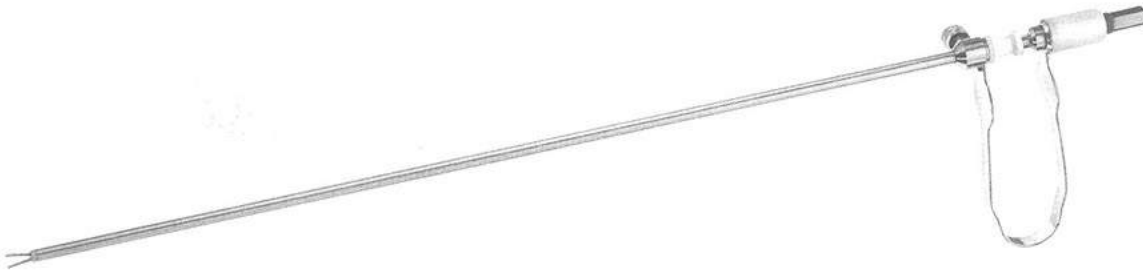

**13-1630** Bipolar forceps, delicate serrated, 5 mm shaft



**13-1635** Bipolar forceps, 5 mm shaft

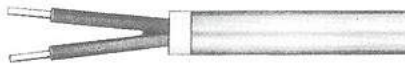

**13-1640** Bipolar forceps, 5 mm shaft

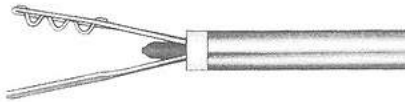

**13-1642** Bipolar forceps, 5 mm shaft, as 13-1630, no nose

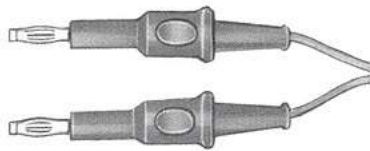

**13-1641** Bipolar cable for US-Generators



**13-1643** Bipolar cable for Erbe Generators



**13-1644** Bipolar cable for Martin / Berchtold Generators



# BIPOLAR COAGULATION FORCEPS

## DISPOSABLE INSERTS



**13-1633ri** Outer and inner sheath, for disposable inserts



**13-1630di** Bipolar insert



**13-1634di** Bipolar insert, wide jaw, Kleppening

**13-1630si** Handle, only, for disposable inserts

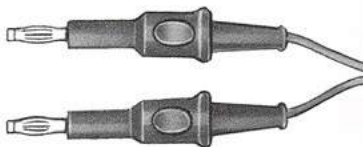

**13-1641VASL** Bipolar cable for US-Generators

finest  
INSTRUMENTS

S  
P  
E  
E  
D  
L  
O  
C  
K<sup>®</sup>